

DX3



PROTECTION
THAT MEETS YOUR
REQUIREMENTS

→ CATALOGUE PAGES INSIDE

GLOBAL SPECIALIST IN ELECTRICAL AND
DIGITAL BUILDING INFRASTRUCTURES

 **legrand**[®]

THE NEW DX³ OFFER

Legrand offers you leading-edge technical features with its new DX³ range of modular circuit breakers.

This range, up to 125 A, is suitable for all residential, commercial and industrial applications which require high performance, selectivity and back-up combination of devices. In this document, discover the innovations of this new range which will enable you to build more reliable, higher performance and more economical distribution boards.



PROTECTION/BREAKING

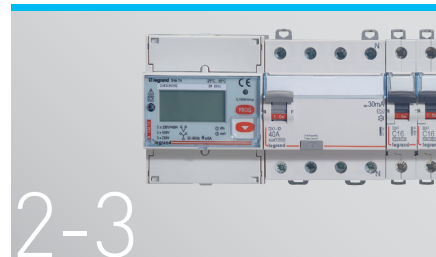

A clear, comprehensive offer for all types of application

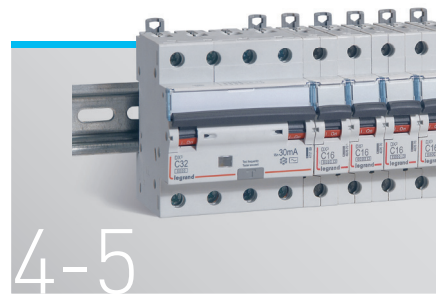

Performance that meets your requirements

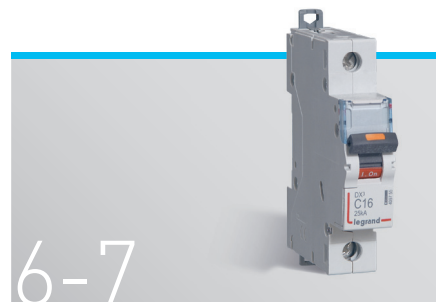

Clear identification of each circuit



8-9

Impeccable quality

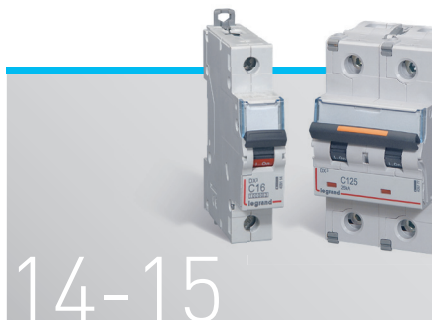

14-15

Easy, safe connection

CONTROL



22-23

More comfortable buildings and energy savings

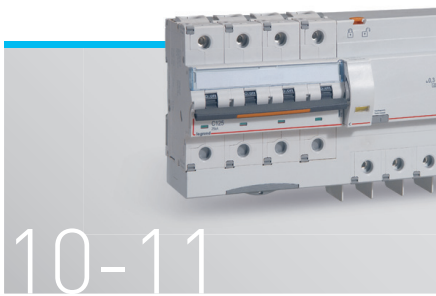

10-11

Protection tailored to your requirements

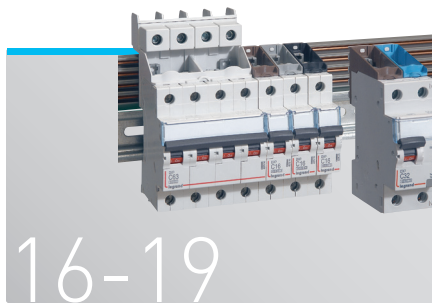

16-19

Choose your distribution

MEASUREMENT



24-25

Measurement at the heart of energy efficiency

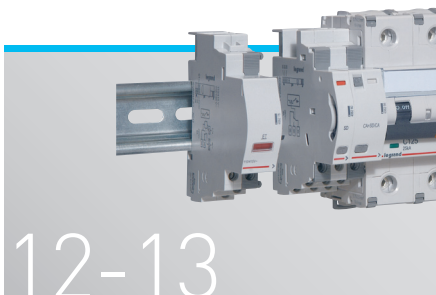

12-13

Perfect control of your installation

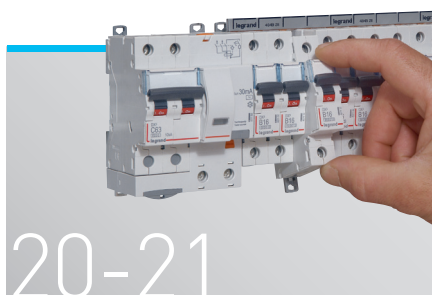

20-21

Easy operation and maintenance

26-63

Catalogue pages

LEGRAND, A CLEAR, COMPREHENSIVE OFFER FOR ALL TYPES OF APPLICATION



The new DX³ circuit breakers

can be integrated in a wide range of products, providing exceptional technical and economic performance levels

The variety of functions and range of characteristics offered will enable you to equip all your distribution boards. The very high levels of coordination between the various ranges of DX³ modular circuit breakers or between DX³ modular circuit breakers and DPX³ MCCBs enable the cost of the installation to be optimised.

MEASUREMENT

PROTECTION/BREAKING

CONTROL

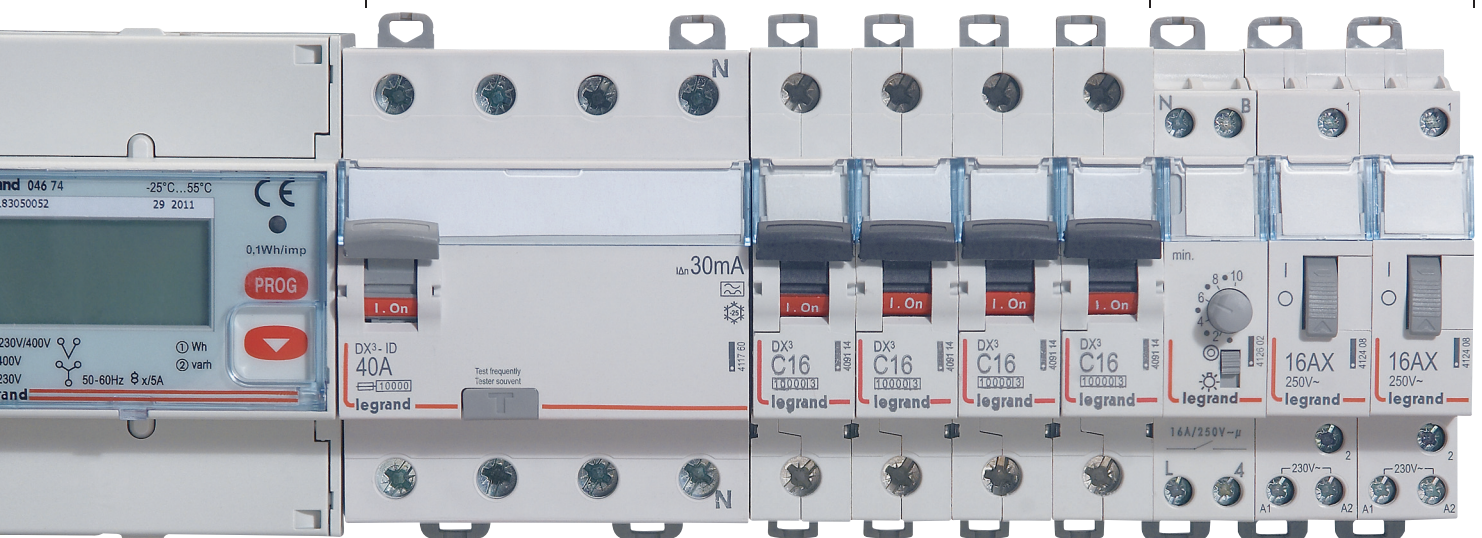

All functions on DIN rail



Each breaking capacity has its own power solution

Perfect complementarity for your distribution boards up to 6300 A and 100 kA breaking capacity.

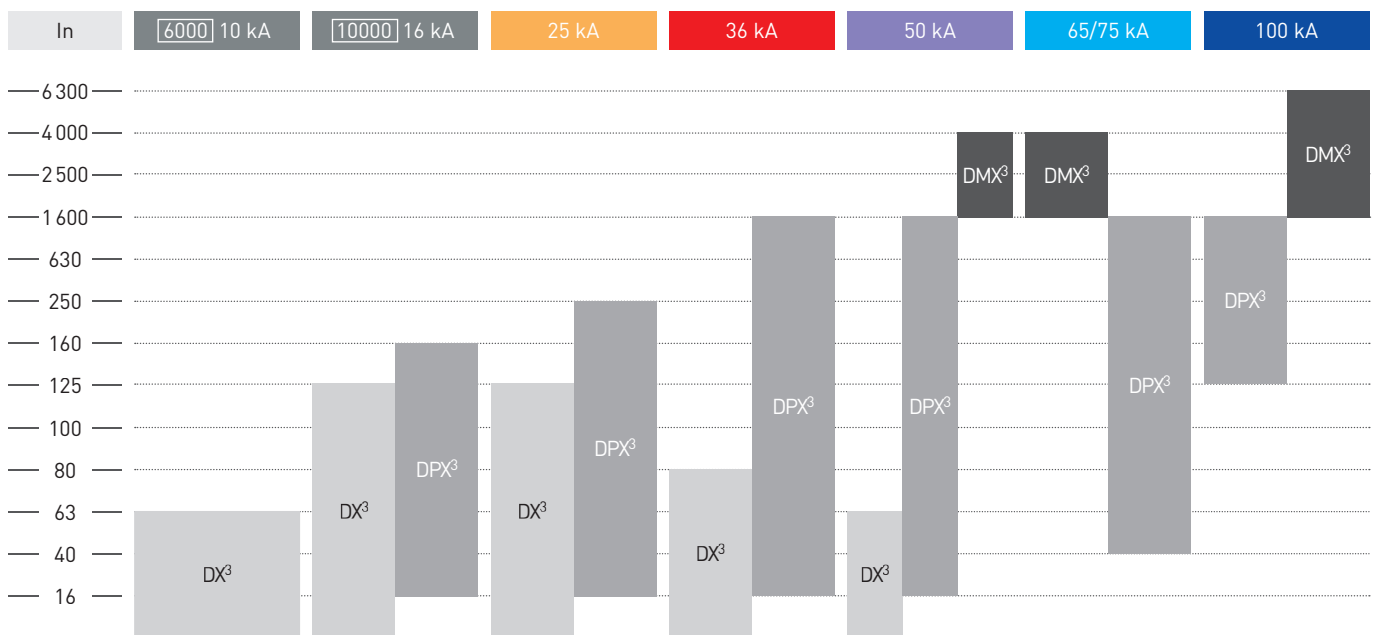
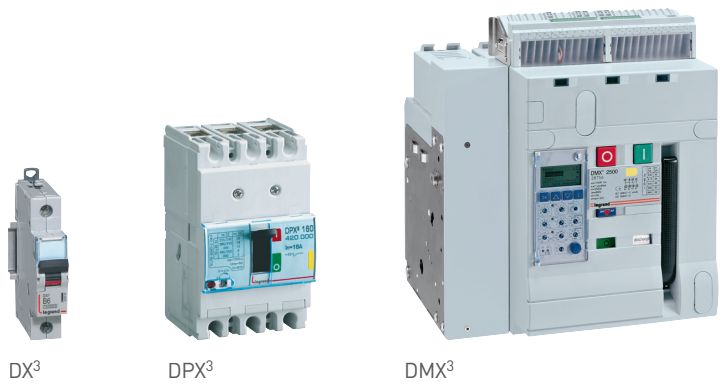

PERFORMANCE THAT MEETS YOUR REQUIREMENTS

The DX³ range is designed to meet the efficiency, safety and compliance requirements with which new electrical installations must comply.

Nominal current, breaking capacity, number of poles, tripping curve, discrimination: the electrical characteristics of the new DX³ circuit breakers have been designed to meet the needs of all types of installations, from residential buildings to the largest industrial sites, including commercial buildings of all sizes.

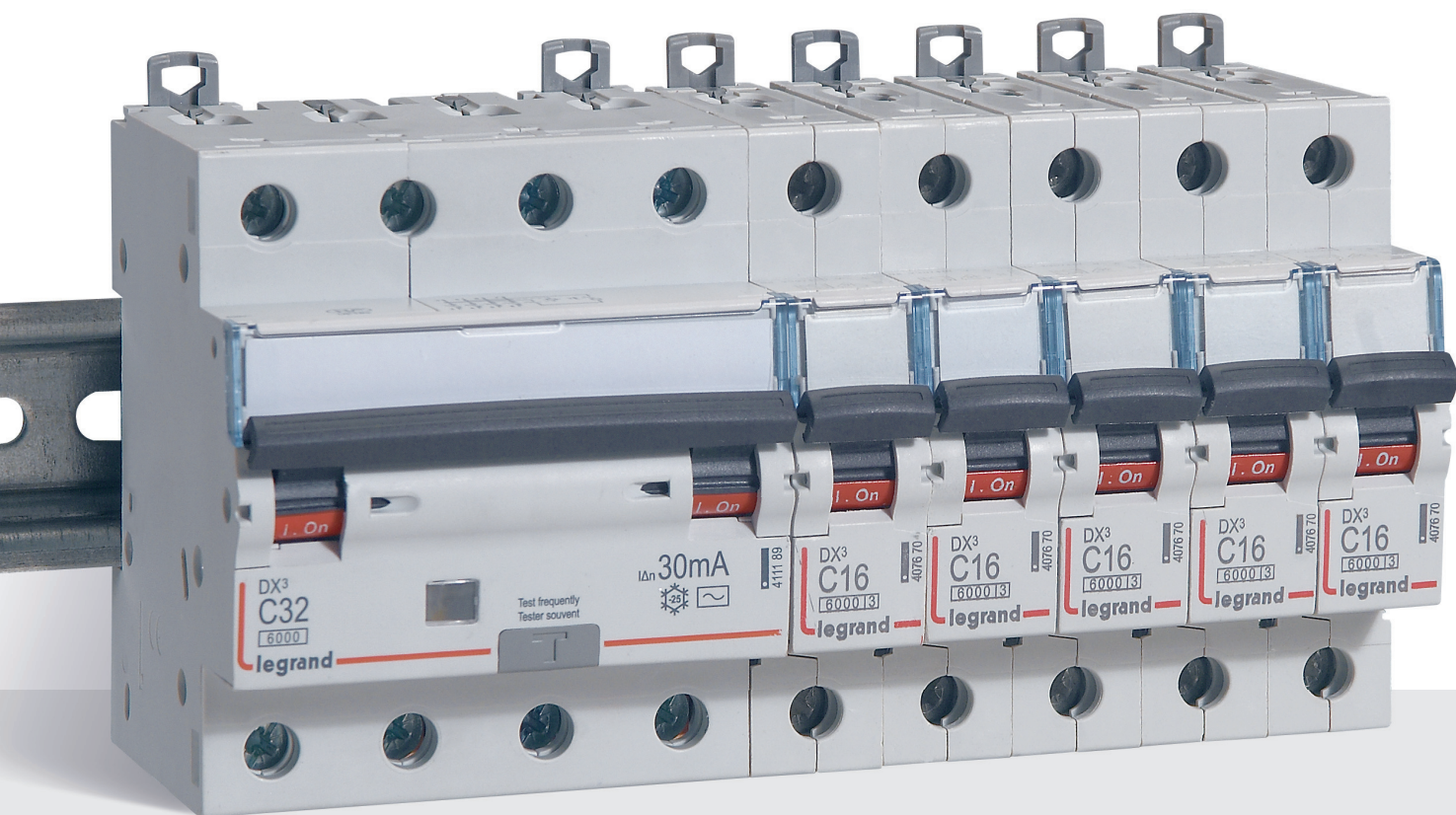

Compact:
10 to 32 A 4-pole DX³ RCBO only 4
modules, protected neutral.

DX³ performance

A comprehensive, uniform range up to 125 A nominal current and 50 kA breaking capacity in a compact unit (1 or 1.5 modules/pole).



DX³ circuit breakers are limitation class 3: they limit the short-circuit power in the cables and can prolong the installation's life by avoiding damage to the cables resulting from the stresses caused by the power flowing through them. The products never work at the "limit" of their capacity.

The information in the table applies to 1P, 3P and 4P circuit breakers. For further information on the number of modules per pole, please refer to the catalogue pages.

⁽¹⁾ Exists also in MA version (magnetic release only) and Z curve

⁽²⁾ Exists also in MA version (magnetic release only)

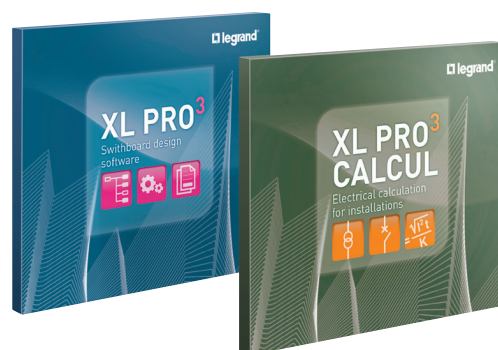

THE XL PRO CALCUL AND XL PRO³ software include the whole DX³ range for building perfect distribution boards.

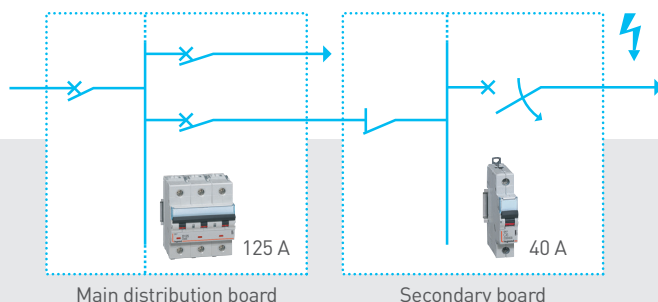

The tripping characteristics are calculated and adjusted to ensure correct discrimination between the different protection levels in order to improve ease of use.

CONTINUITY OF SERVICE: OPTIMUM DISCRIMINATION

The excellent discrimination between DX³ circuit breakers and with DPX or DPX³ MCCBs ensures optimum continuity of service for your installations.

CLEAR IDENTIFICATION OF EACH CIRCUIT



At the head of
distribution boards,
at the head of rows
or to protect outgoing
lines up to 125 A.
There is always a
DX³ solution

Quick identification of devices and circuits is a guarantee of efficiency not only for installation but also for operation and maintenance. Legrand has always taken great care with the marking and ease of identification of its circuit breakers.

The DX³ range includes new enhancements so that your distribution boards are even easier to use.

Technical labelling area



Innovative label-holder:

- Improved opening
- Enhanced dust protection
- Label remains firmly in place during transport



Identification

Dual identification of the breaking capacity and clear marking for easier maintenance

Black handle: circuit breakers
Grey handle: switches

Colour marking for the breaking capacity

- 25 kA █
- 36 kA █
- 50 kA █

Curve

Rating

Breaking capacity

Limitation class 3 (on concerned ratings and breaking capacities)



STATE OF THE CIRCUIT BREAKER

Can be identified quickly via the colour marking on the handle:

- I-On/red
- O-Off/green

DX³ IMPECCABLE QUALITY



Legrand pays particular attention to how these devices perform: each of them is set and checked individually on the production lines

Isolating switches, RCDs, circuit breakers, RCBOs, add-on modules, control and signalling auxiliaries: the guarantee of finding the function you need with a uniform appearance and optimised dimensions.



CERTIFICATION OF LEGRAND'S FACTORIES:

- ISO 9001 for quality
- ISO 14001 for environmental protection

DX³ PRODUCTS ARE CERTIFIED IN ACCORDANCE WITH INTERNATIONAL PRODUCT STANDARDS.

Approvals, such as VDE, which are universally recognised for the rigour of their requirements, are renewed annually.

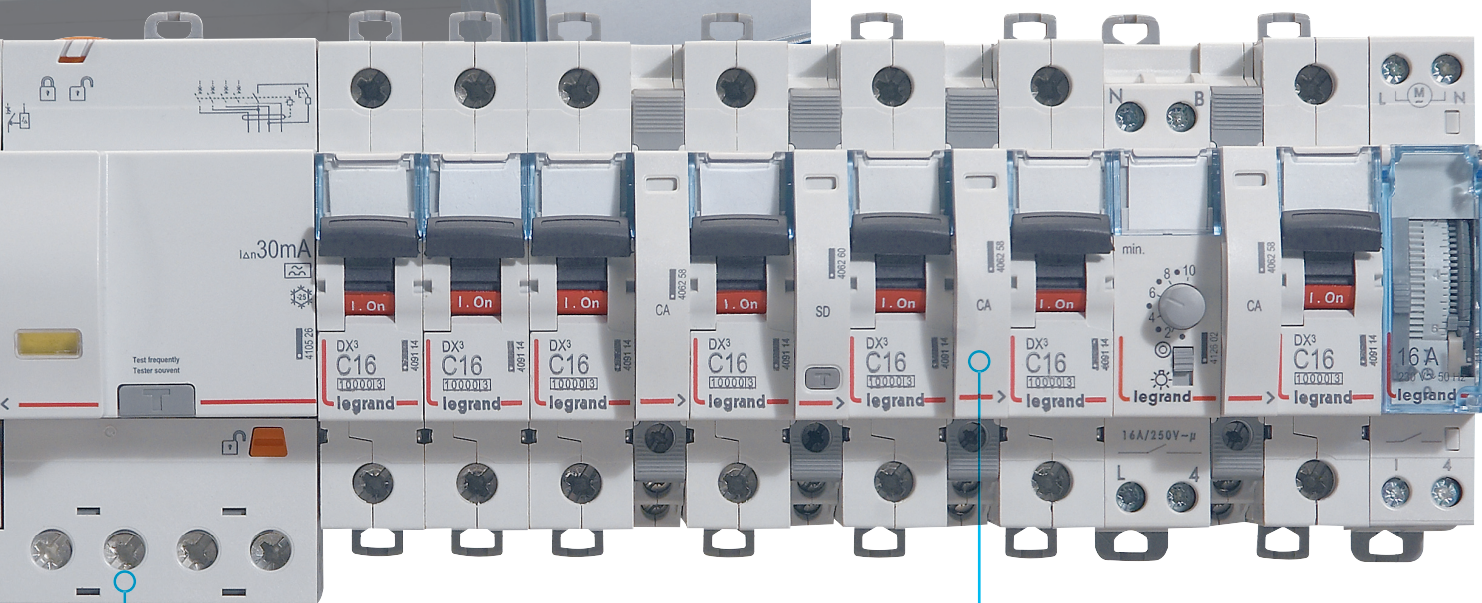
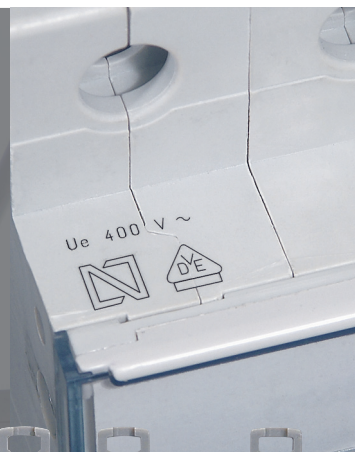

All DX³ circuit breakers can be used with an add-on module (see page 10).

The DX³ control and signalling auxiliaries are common to all the protection devices irrespective of their size (1 or 1.5 modules per pole) (see page 12).



COPYTRACER, THE FIGHT AGAINST COUNTERFEITING

Copytracer is a unique registration number that is marked on some of our products. The number is stored in a database.

Go to the website: www.legrand-copytracer.com

PROTECTION TAILORED TO YOUR REQUIREMENTS

With the
DX³ add-on modules

The new DX³ add-on modules have a wide range of features to meet the most stringent requirements for the protection of people. Like the new DX³ circuit breakers, they offer high performance levels and incorporate innovative solutions for installation and operation.

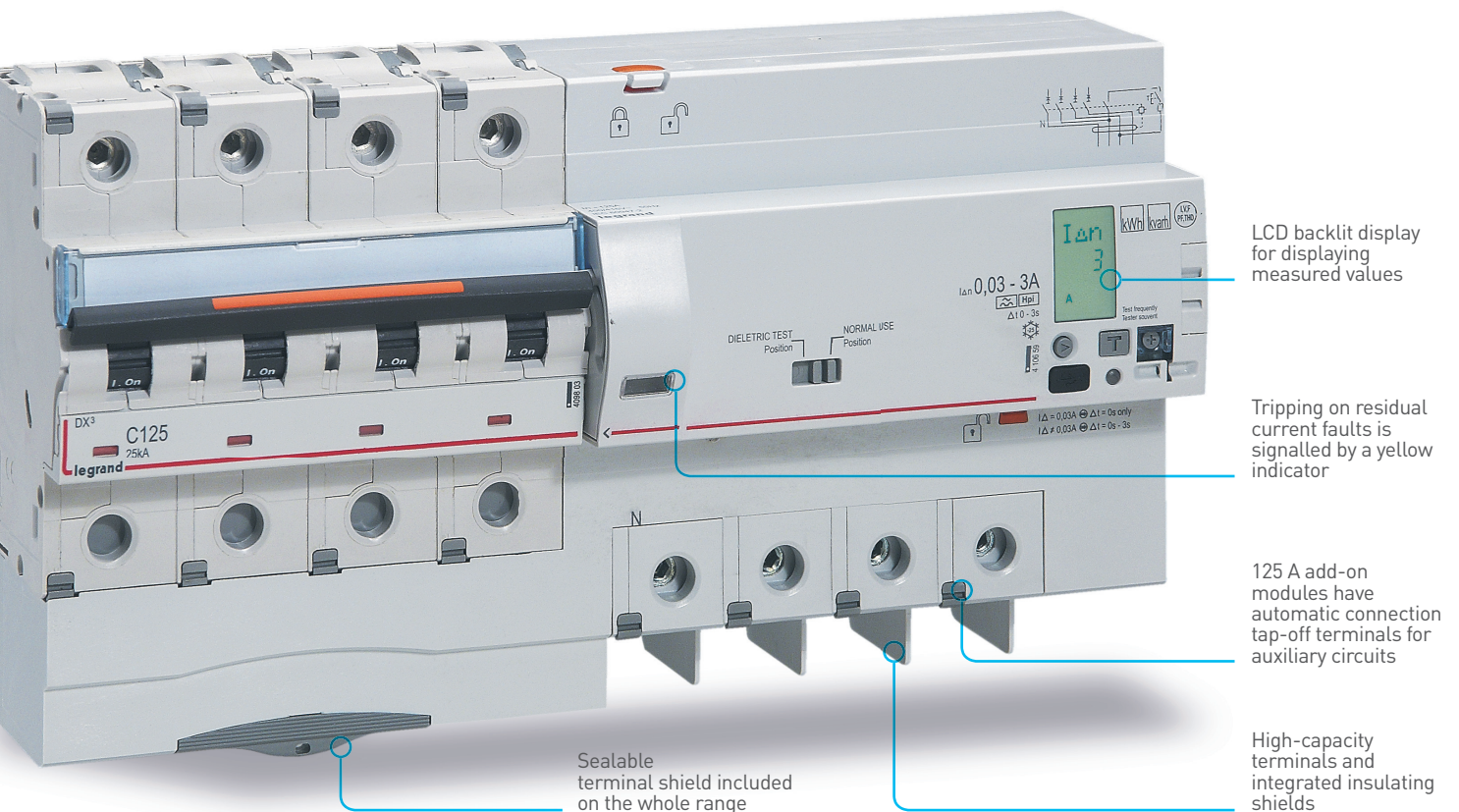

LCD backlit display for displaying measured values

Tripping on residual current faults is signalled by a yellow indicator

125 A add-on modules have automatic connection tap-off terminals for auxiliary circuits

High-capacity terminals and integrated insulating shields

Sealable terminal shield included on the whole range

A single mounting principle for all DX³ add-on modules

It has never been so quick and safe to fit an add-on module.

The exclusive Legrand system, common to the whole DX³ range, makes the assembly extremely strong and provides guaranteed safety.

Version	FIXED				ADJUSTABLE		WITH ENERGY METER		WITH MEASUREMENT CONTROL UNIT
Sensitivity	30 mA		300 mA		300-500-1 000 mA		30-300-1 000-3 000 mA		30-300-1 000-3 000 mA
Time delay	Instantaneous		Instantaneous		0-60-150 ms		0-300 ms-1-3 s		0-300 ms-1-3 s
Max. current	63 A	125 A	63 A	125 A	63 A	125 A	63 A	125 A	125 A
AC type	4P	•		•					
A and type Hpi	2P	•	•		•	•			
	3P	•	•	•	•	•			
	4P	•	•	•	•	•	•	•	•



Maximum continuity of service

DX³ adjustable add-on modules can provide discrimination up to 3 levels by adjusting their sensitivity. They enable those parts of the installation that are not affected by a fault to remain operational, while ensuring total safety of people.

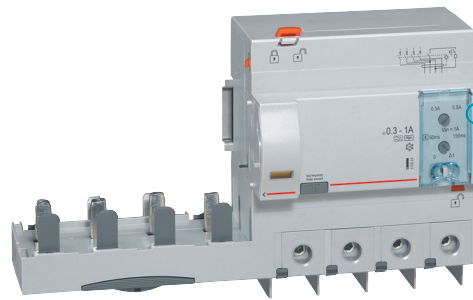

4P - 125 A ADD-ON MODULE adjustable version



Easy to access settings on the front panel with sealable transparent cover

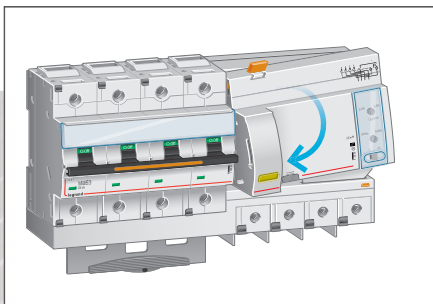

FIT THE CIRCUIT BREAKER and the add-on module

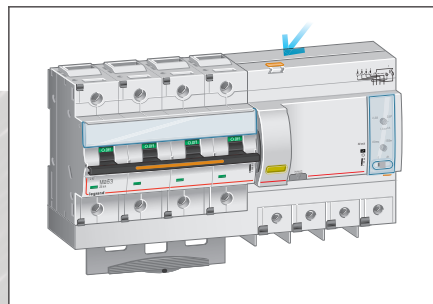

LOCK THE COMBINATION TOGETHER

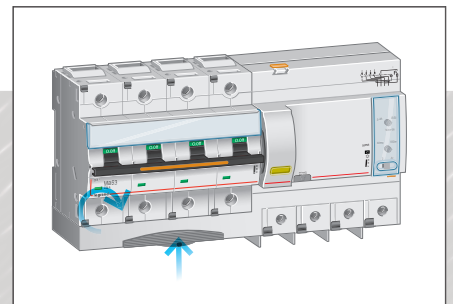

TIGHTEN THE TERMINALS and fit the terminal shield

PERFECT CONTROL OF YOUR INSTALLATION



The DX³ range
has a selection
of electrical
auxiliaries
for monitoring
and controlling
circuits remotely

Auxiliary contacts and fault
signal contacts, shunt trips,
undervoltage releases,
motorised controls and
automatic reclosers

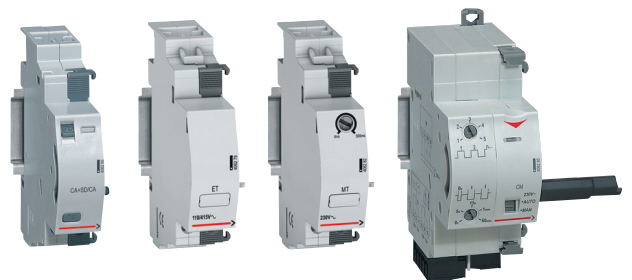

THE AUXILIARIES FIT FIRMLY WITHOUT the need for any tools and ensure the whole assembly is robust

THE ACCESSIBILITY OF THE TERMINALS and the visibility of the screw heads make the installer's work easier

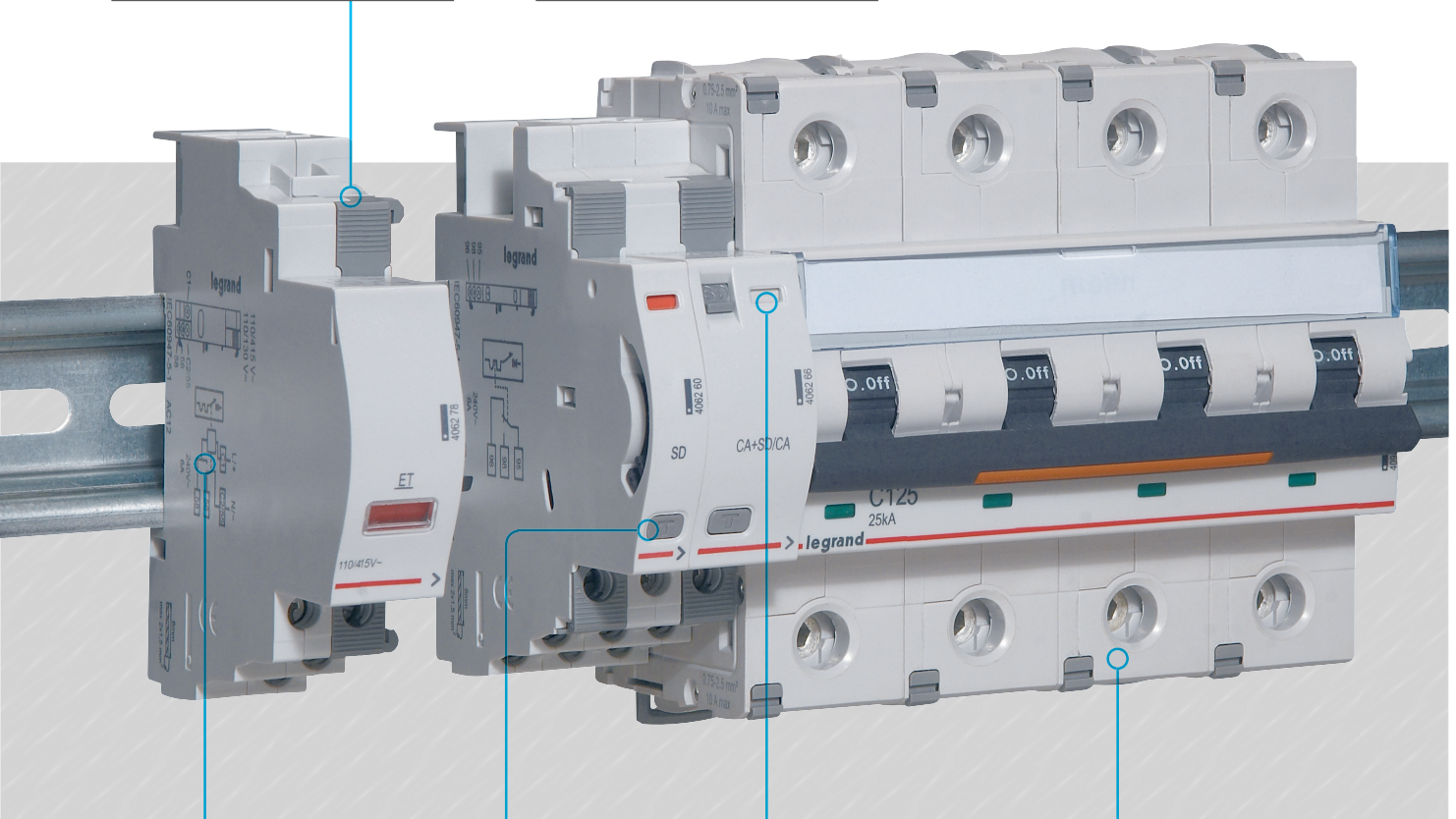
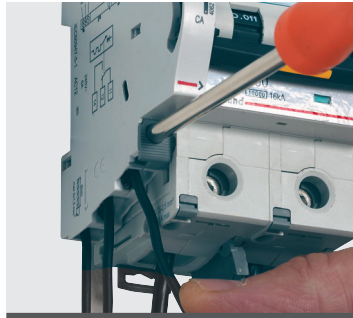
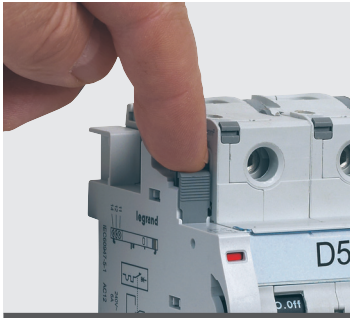

Marking of auxiliaries (characteristics, connection, mounting)

The fault signal contacts have a test button

The colour code of the indicators on the signalling auxiliaries is the same as that of the remote indicators

DX³ circuit breakers take up to 3 auxiliaries including one control auxiliary



DX³ motorised controls can be used with 1 module per pole devices (circuit breakers, RCBs and RCCBs) just as easily as auxiliaries.

OPTIMISED SPACE IN THE DISTRIBUTION BOARD

Legrand motorised controls are the most compact on the market: 1 module wide. They save a great deal of space inside the distribution board.

EASY, SAFE CONNECTION



Safety is prioritised with the innovative features of the DX³ products

The quality and hold of the connections are vital for the safety of distribution boards. This is why Legrand, with its wealth of experience and expertise, has broken new ground again with terminals with a loosening compensation system and retractable insulating shields.



1 MODULE/POLE
Terminal capacity :
In ≤ 63 A → 35 mm²



1,5 MODULES/POLE
Terminal capacity :
In ≤ 63 A → 50 mm²
In ≥ 80 A → 70 mm²

WIRE GUIDE FLAP
ensures the wire is in the correct position

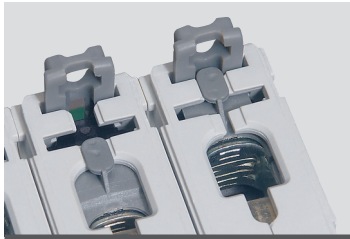

RISING CLAMP TERMINALS
ensure a high quality, durable connection

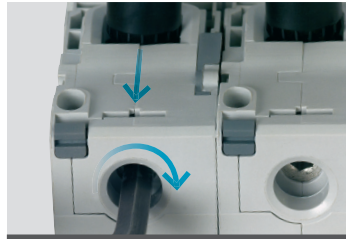

RELIABLE CONNECTIONS
Compensation for the effect of loosening to ensure excellent hold over time and consistent contact ($I_n \geq 80 \text{ A}$)



1
module/pole

1,5
modules/pole



Clamping screw for flat or pozidriv screwdriver. Tightening torques higher than those recommended by the standard



The use of an Allen key makes it easier to tighten to the required torque ($I_n \geq 80 \text{ A}$)



RETRACTABLE INSULATING SHIELDS

With the integrated retractable insulating shields, no additional accessories are needed to isolate the connections on all breaking capacities and high ratings of the 1.5 modules/pole circuit breakers.

CHOOSE YOUR DISTRIBUTION

A wide range of distribution devices is available for your modular rows

From the simple supply busbar to the HX³ 125 A plug-in distribution block, whether they have conventional screw connections or more innovative automatic terminal connections, or plug in directly, Legrand quality is always there.

STANDARD DISTRIBUTION Supply busbars

DX³ 1 module/pole devices up to 63 A can be connected to supply busbars via the top or the bottom.

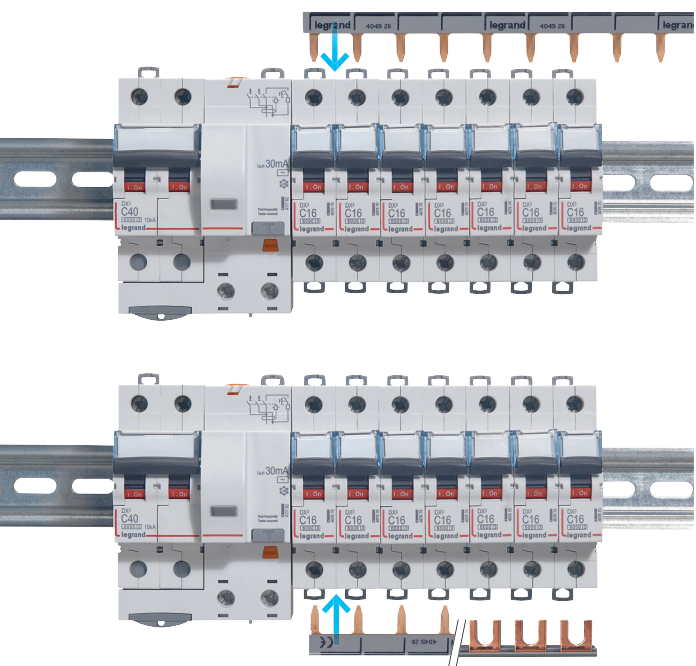

STANDARD DISTRIBUTION Modular distribution blocks

The 40 to 250 A modular distribution blocks are totally universal, making them suitable for all types of distribution board.

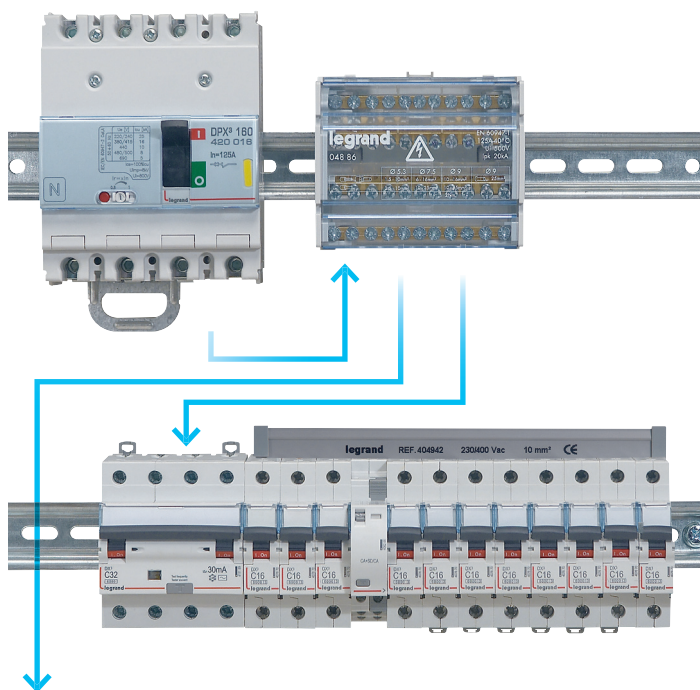

Four-pole distribution

For three-phase horizontal distribution in a single action.





OPTIMISED DISTRIBUTION VX³ 63 and 125 A, vertical distribution blocks with automatic terminals

- Significant space saving due to their vertical installation beside the rows
- Time saving as there is less wiring with the IP 2x automatic terminals for flexible or rigid wires.

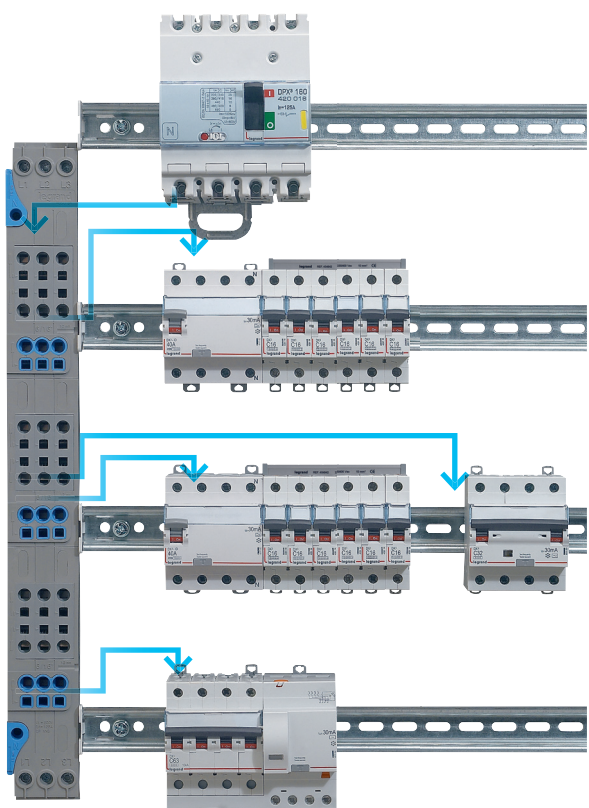

Mounting in Legrand enclosures:
Plexo³, XL³125, 160, 3 to 6 rows

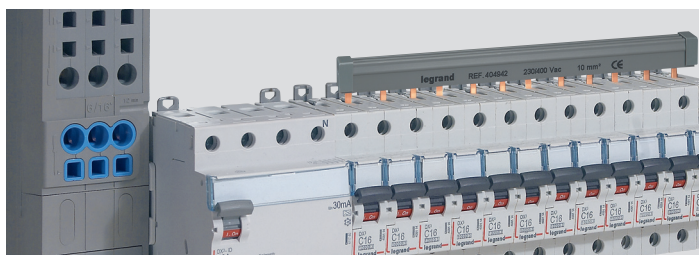

SUPPLY BUSBARS, AN IDEAL ADDITION

In addition to 4-pole vertical distribution blocks with automatic terminals, supply busbars power the devices in each row via the "head of row" protection device.

CHOOSE YOUR DISTRIBUTION (continued)

Legrand optimised distribution has been designed for maximum safety and for ease of installation and maintenance of distribution boards

Wiring and tedious tightening operations are minimised, and the risks of poor contact and short-circuits are reduced while mounting time is optimised.

OPTIMISED DISTRIBUTION HX³ 125 A horizontal distribution blocks with automatic terminals

Horizontal 4-pole distribution for
XL³ 160 to 4000 enclosures:

- Freedom to mix 1P, 1P+N, 2P, 3P and 4P devices on the same row
- Space saving: installed between the rows
- Time saving: less wiring, 1P 2x automatic terminals for flexible or rigid wires

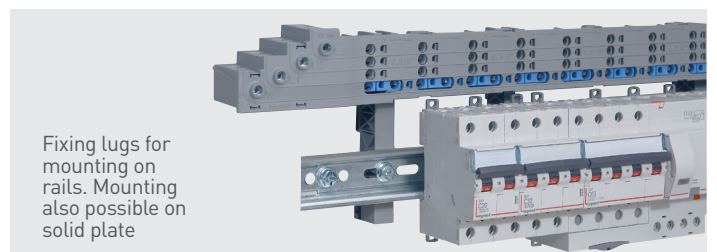
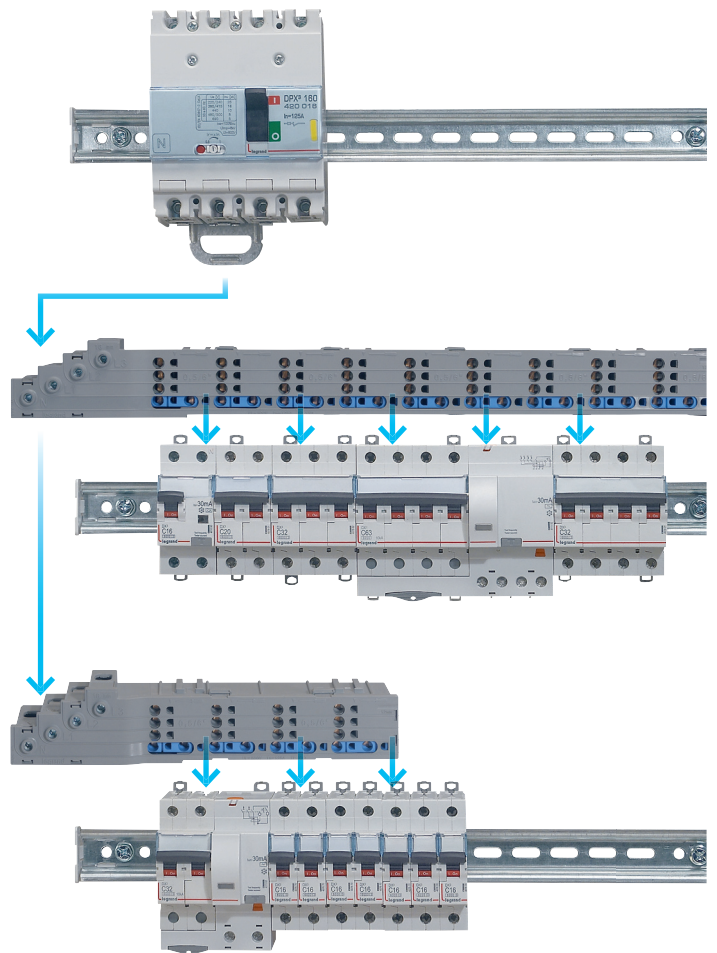

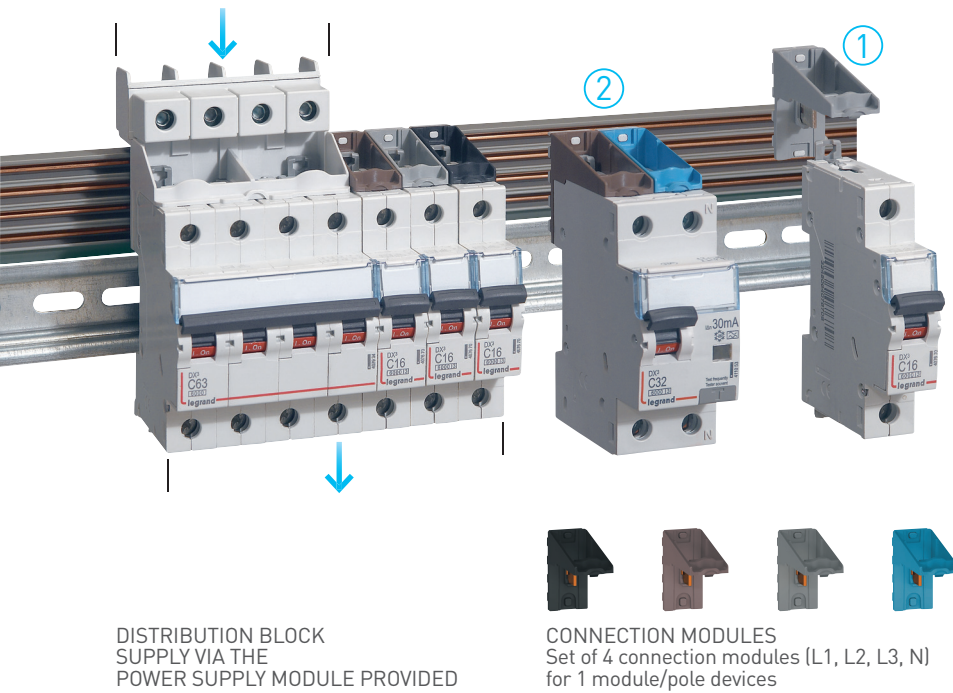

OPTIMISED DISTRIBUTION
HX³ 125 A
 horizontal distribution blocks with plug-in connection

Horizontal 4-pole distribution for XL³ 160 to 4000 enclosures:

- Optimised design: freedom to mix 1P, 1P+N, 2P, 3P and 4P devices on the same row
- Optimised installation: automatic connection with no wiring or clamping
- Safe connection and disconnection of devices, even when the distribution block is powered-up (due to the IP xxB insulation of the distribution block and the integral connection modules in the devices).

DISTRIBUTION BLOCK SUPPLY VIA THE POWER SUPPLY MODULE PROVIDED

CONNECTION MODULES
 Set of 4 connection modules (L1, L2, L3, N) for 1 module/pole devices

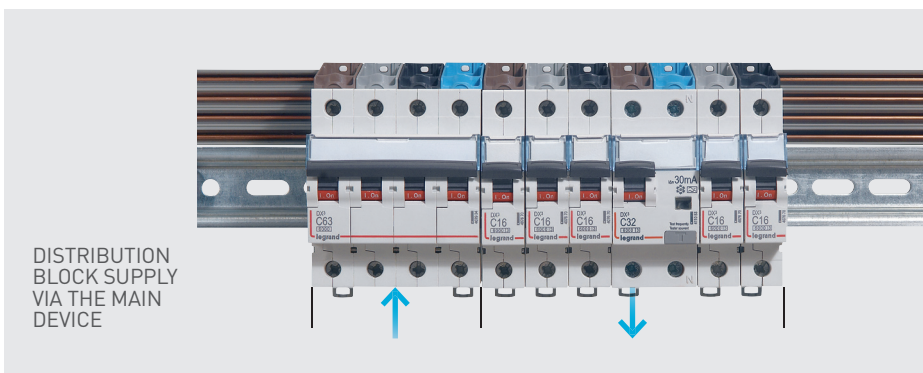

DISTRIBUTION BLOCK SUPPLY VIA THE MAIN DEVICE

EASY CONNECTION

Circuit breakers with plug-in terminals are fixed onto the distribution block with no need for any tool. The phase to be connected is determined by the choice of connector. The distribution block can be supplied via the power supply module provided or via the head of row device.

EASY OPERATION AND MAINTENANCE



When designing
the DX³ range,
Legrand did not
forget about
users and
maintenance
engineers

As well as the already well-known functions such as the double clip which enables maintenance to be carried out on the module, new features such as the labelling area, automatic connection tap-off terminals and status indicators have been added to make day-to-day use of distribution boards even easier.

EASY TAP-OFF CONNECTION FROM 80 A
 The IP 2x automatic tap-off terminals can be used to connect an auxiliary circuit or a measuring device safely

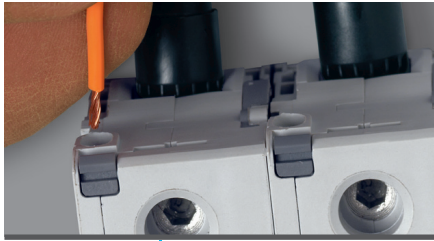

INCREASED SAFETY
 The DX³ range guarantees IP2x protection. There is no risk of contact with live parts, even when the faceplate is open.

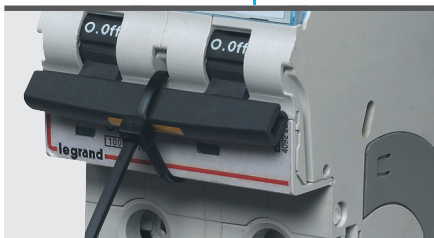
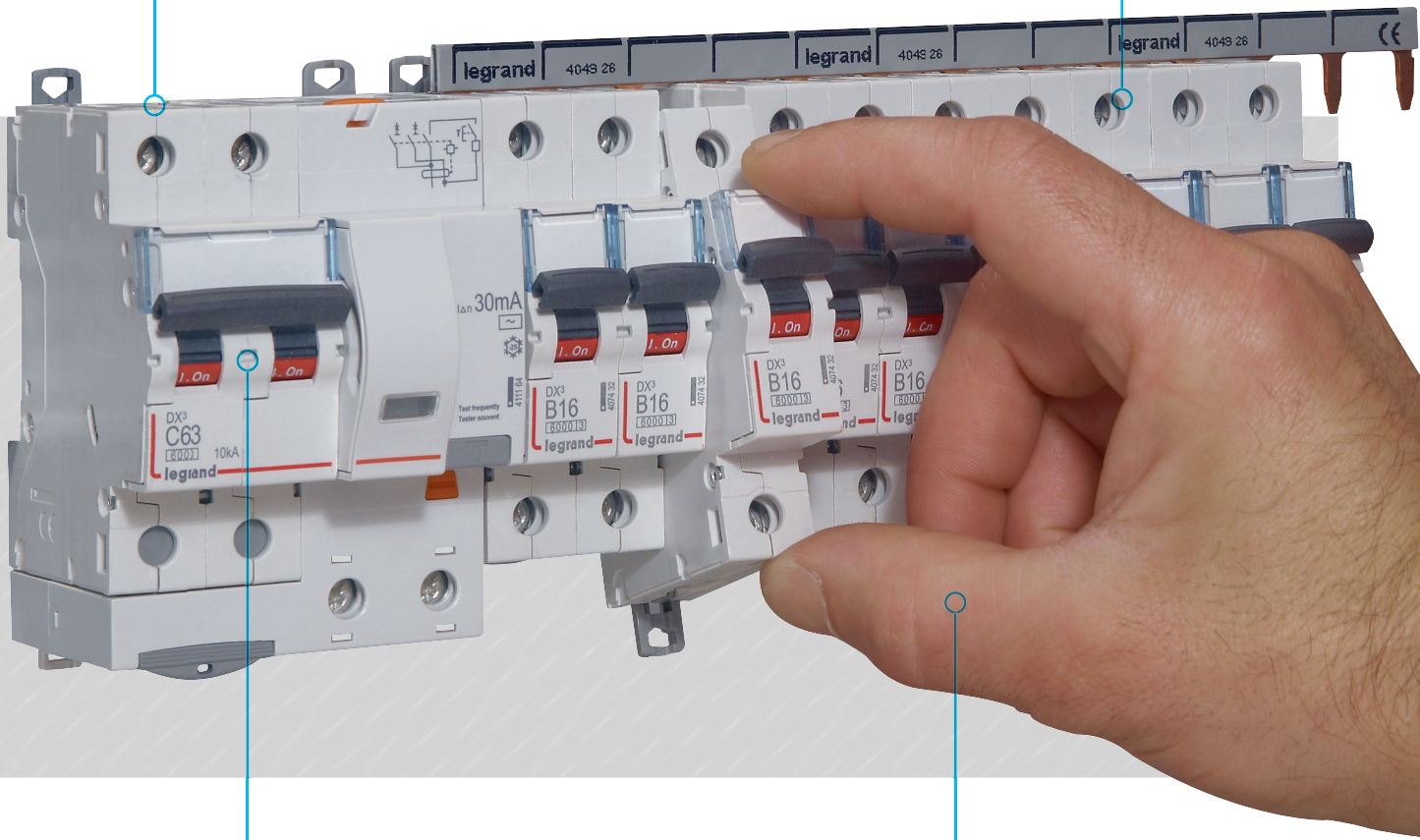
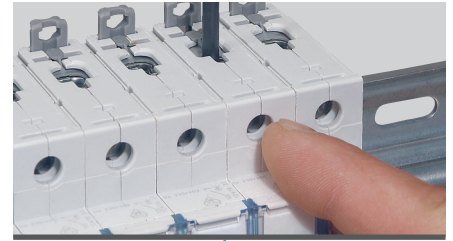

LOCKING IN OPEN POSITION
 for 1.5 module per pole devices using a single Colring cable tie

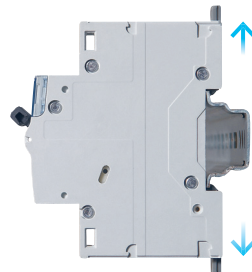

THE DOUBLE CLIP
 enables a device to be replaced without disconnecting the whole row

MORE COMFORTABLE BUILDINGS AND ENERGY SAVINGS

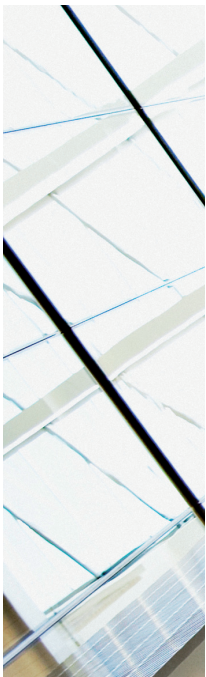

CX³ modular control and monitoring devices are a perfect addition to the range of DX³ protection devices

With the same design, they integrate perfectly in your distribution boards. Power contactors, pulse operated latching relays, pushbuttons, indicators, timers, programmers, etc. With the selection of functions available it is simple to improve the safety, efficiency and comfort of installations and meet energy requirements.



CHANGEOVER SWITCHES AND PUSH-BUTTONS compatible with fluorescent lamps (20 AX)



INDICATORS AND ILLUMINATED PUSH-BUTTONS equipped with long life LED lamps for common use or specially adapted for ELV circuits and DC applications

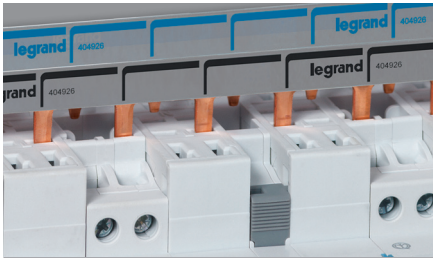

SUPPLY BUSBAR INSERTION

There is a position on the top of the control devices for inserting the supply busbar

LIGHT SENSITIVE SWITCH to switch lighting on automatically when the natural light decreases

16 A TO 63 A LEGRAND POWER CONTACTORS are available with 24 VAC or 230 VAC coil

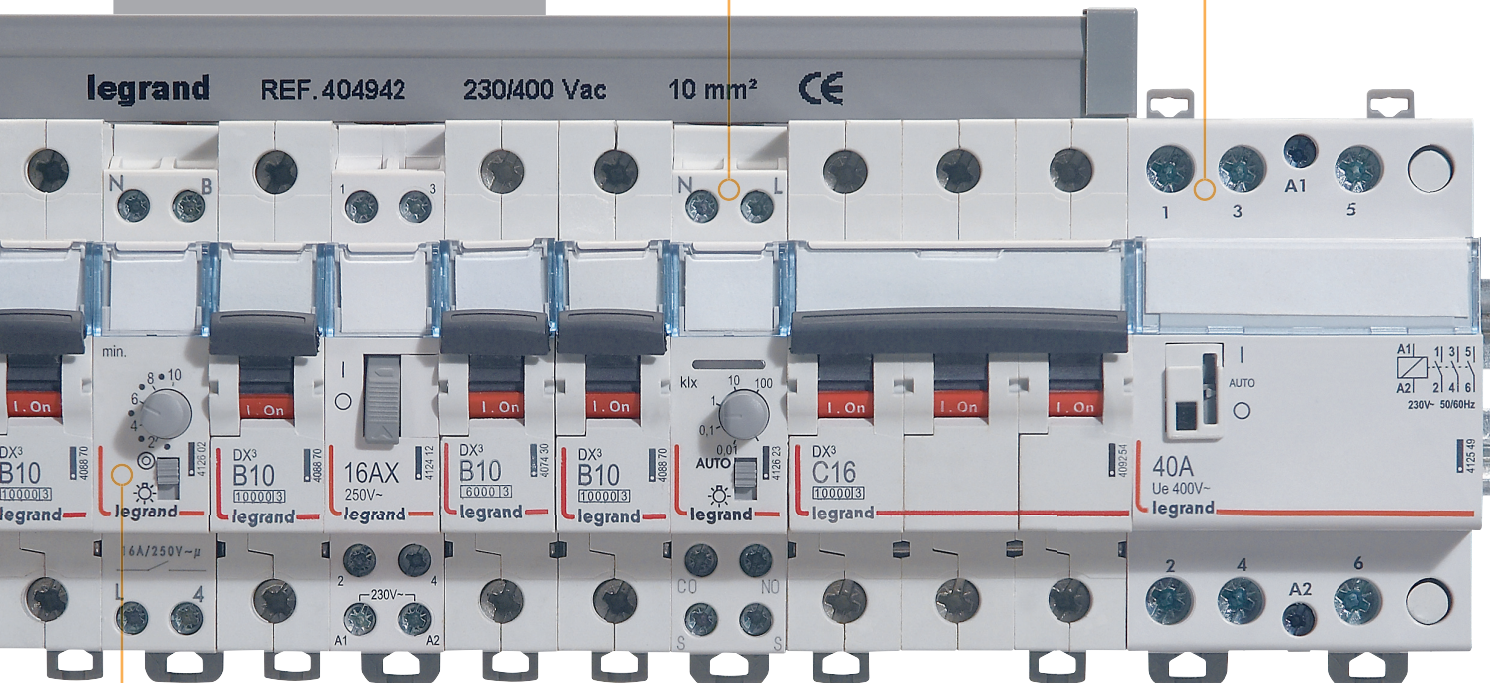

TIMER
to switch off of lighting automatically after an adjustable period of 0.5 s to 10 min



- 1 to 4 x 16 A outputs
- 24-hour, 7-day or annual programming
- Programming direct or from a PC with a transfer key

ENERGY SAVINGS WITH TIMERS

In order to optimise power consumption, Legrand electronic timers can be used to assign operating periods, for example for heating or lighting.

MEASUREMENT AT THE HEART OF ENERGY EFFICIENCY

A project to optimise
quality and 
energy efficiency must
include measurement

Measurement upstream, to identify the critical points and ensure optimum targeting of the actions to be taken. Downstream to monitor the effects and control any drift. Legrand EMDX³ measurement control units and electricity meters will naturally have a place in distribution boards.

EMDX³ measurement control units

All the essential parameters of
the installation on DIN rail or on the door :

- Dual tariff metering
- Active and reactive energy
- Operating time
- Power factor
- Harmonic distortion
- Programmable alarms



EMDX³ UNIT ON DIN RAIL



EMDX³ UNIT ON DOOR
EMDX³ units on doors provide a large size display and their capacity can be increased with extension modules.



ECO-DESIGN A VOLUNTARY APPROACH

The Legrand group has been taking environmental problems into account since 2001. This approach is based on international standards for the objective measurement of the environmental impacts of products in terms of both consumption of resources and pollution. Legrand publishes these reports in the form of PEP (Product Environmental Profile) sheets.

Remote supervision and viewing

With the Legrand communication interfaces (RS 485, IP), supervision software and Web servers, measurements can be centralised and displayed remotely on a PC, tablet or smartphone.



DISPLAY OF 32 MEASUREMENT POINTS
ON TABLET COMPUTERS AND WEB SERVERS

Integrated measurement: choosing a more compact solution

Integrated measurement is available on the DMX³, DPX³ and DX³ ranges. The panel board display is an innovative solution, allowing to integrate information coming from 8 different devices DX³, DPX³, DMX³ or EMDX³ control units.





DIN RAIL equipment

ISOLATING SWITCHES, RCDs and RCBOs



P. 28
DX³-IS
isolating switches
from 16 to 125 A

MCBs



P. 34
DX³ 6000 - 10 kA
MCBs from 0.5 to 63 A

Add-on modules



P. 42
DX³ 2-pole
add-on modules
for 1 module/pole
MCBs

Auxiliaires, remote control and accessories



P. 44
Signalling
auxiliaires

Other control functions



P. 53
Pulse operated
latching relays

EMDX³ electrical energy meters & measuring units



P. 69
EMDX³
electrical energy
meters

DISCOVER THE PRODUCTS

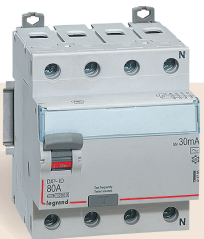

DX³ - ID
RCDs
(p. 29)

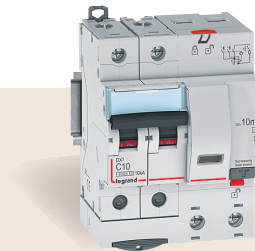

DX³
RCBOs
(p. 32)



P. 29
DX³-ID
RCCBs
from 16 to 100 A

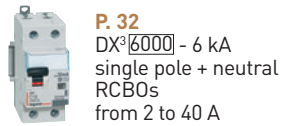

P. 32
DX³ 6000 - 6 kA
single pole + neutral
RCBOs
from 2 to 40 A

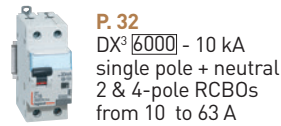

P. 32
DX³ 6000 - 10 kA
single pole + neutral
2 & 4-pole RCBOs
from 10 to 63 A



P. 33
DX³ 10000 - 16 kA
single pole + neutral
RCBOs
from 6 to 40 A

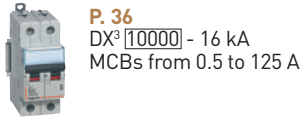

P. 36
DX³ 10000 - 16 kA
MCBs from 0.5 to 125 A



P. 38
DX³ 25 kA
MCBs
from 2 to 125 A



P. 40
DX³ 36 kA
MCBs
from 10 to 80 A

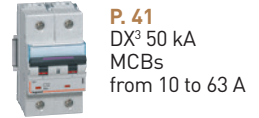

P. 41
DX³ 50 kA
MCBs
from 10 to 63 A



P. 42
DX³ 3-pole
add-on modules
for 1 module/pole
MCBs



P. 42
DX³ 4-pole
add-on modules
for 1 module/pole
MCBs

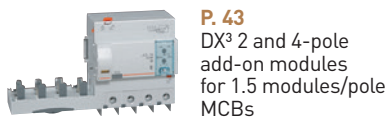

P. 43
DX³ 2 and 4-pole
add-on modules
for 1.5 modules/pole
MCBs

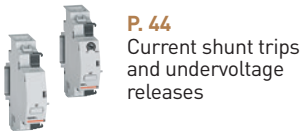

P. 44
Current shunt trips
and undervoltage
releases



P. 45
Motorised
controls



P. 45
STOP&GO
automatic
resetting

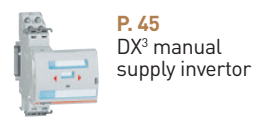

P. 45
DX³ manual
supply inverter



P. 55
CX³
power
contactors

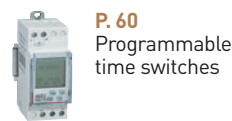

P. 60
Programmable
time switches

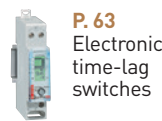

P. 63
Electronic
time-lag
switches

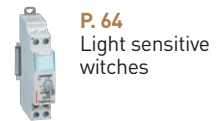

P. 64
Light sensitive
switches



P. 69
EMDX³
DIN rail mounting
multi-function
measuring units



P. 70
EMDX³
door mounting
multi-function
measuring units



P. 74
Current
transformers

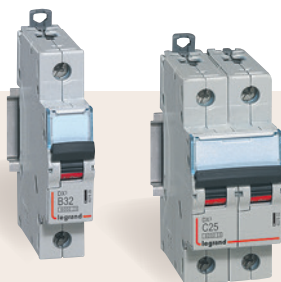

DX³
MCBs
(p. 34)



EMDX³
multi-function
measuring units
(p. 70)

Isolating switches DX³-IS

from 16 A to 125 A

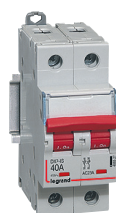

4 065 27

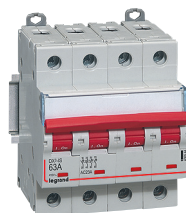

4 065 44



4 064 06



4 064 59



4 064 81

Dimensions **see e-catalogue**
Technical characteristics **p. 30**

AC 23 A according to IEC 60947 - 3, AC 22 A for 125 A
Double break contacts

Pack	Cat.Nos	Remote trip head isolating switches	
		Red handle	
		Visible contact indication	
		Remote tripping with associated control auxiliary (p. 44)	
		Can be fitted with motorised controls (p. 45)	
		Visual indication of the actual status of the contacts:	
		- Closed position (red indicator)	
		- Open position (green indicator)	
		2P - 400 V~	
		Nominal rating In (A)	Number of modules
1	4 065 27	40	2
1	4 065 28	63	2
		3P - 400 V~	
1	4 065 35	40	3
1	4 065 36	63	3
1	4 065 38 ¹	100	4,5
1	4 065 39 ¹	125	4,5
		4P - 400 V~	
1	4 065 43	40	4
1	4 065 44	63	4
1	4 065 46 ¹	100	6
1	4 065 47 ¹	125	6

1: Can be equipped with add-on modules

Pack	Cat.Nos	Isolating switches	
		Grey handle	
		Can be equipped with 1 DX ³ signalling auxiliary (p. 44)	
		1P - 250 V~	
		Nominal rating In (A)	Number of modules
10	4 064 00	16	1
10	4 064 01	20	1
10	4 064 03	32	1
10	4 064 11	40	1
10	4 064 12	63	1
10	4 064 23	100	1
		1P with indicator - 250 V~	
		Supplied with lamp	
10	4 064 04	20	1
10	4 064 06	32	1
		2P - 400 V~	
10	4 064 31	16	1
10	4 064 32	20	1
10	4 064 34	32	1
5	4 064 40	40	2
5	4 064 41	63	2
5	4 064 49	100	2
5	4 064 50	125	2
		2P with indicator - 400 V~	
		Supplied with lamp	
		Do not accept auxiliaries	
10	4 064 36	20	1
10	4 064 38	32	1
10	4 064 39	40	1
		3P - 400 V~	
5	4 064 57	20	2
5	4 064 59	32	2
1	4 064 60	40	3
1	4 064 61	63	3
1	4 064 69	100	3
1	4 064 70	125	3
		4P - 400 V~	
5	4 064 77	20	2
5	4 064 79	32	2
1	4 064 80	40	4
1	4 064 81	63	4
1	4 064 89	100	4
1	4 064 90	125	4

RCCBs - DX³-ID

residual current circuit breakers 16 A to 100 A - AC, A, Hpi and B types

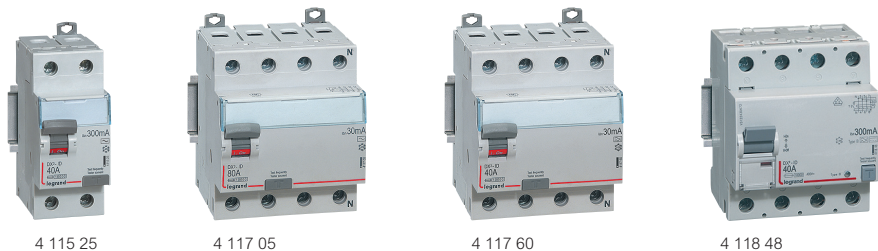

Technical characteristics [see e-catalogue](#)

Conform to IEC 61008 - 1

- AC type : detect sinusoidal AC residual currents
- A type : detect sinusoidal AC and pulsating DC residual currents
- Hpi type (High immunity) : detect AC and pulsating DC residual currents
Enhanced immunity to unwanted tripping in disturbed environments
- B type : detect sinusoidal AC, pulsating DC and smooth DC residual currents

Can be equipped with DX³ signalling and remote tripping auxiliaries, except for B type (p. 44) and motorised controls (p. 45)

Pack	Cat.Nos	2-pole 230 V~			Pack	Cat.Nos	4-pole - 400 V~ - neutral on right-hand side		
		AC type					AC type		
		Sensitivity (mA)	Nominal Rating In (A)	Number of modules		Vis/vis	Sensitivity (mA)	In (A)	Number of modules
1	4 115 00	10	16	2	1	4 117 02	30	25	4
1	4 115 01	10	25	2	1	4 117 03	30	40	4
1	4 115 04	30	25	2	1	4 117 04	30	63	4
1	4 115 05	30	40	2	1	4 117 05	30	80	4
1	4 115 06	30	63	2	1	4 117 12	100	25	4
1	4 115 07	30	80	2	1	4 117 13	100	40	4
1	4 115 08	30	100	2	1	4 117 14	100	63	4
1	4 115 14	100	25	2	1	4 117 15	100	80	4
1	4 115 15	100	40	2	1	4 117 22	300	25	4
1	4 115 16	100	63	2	1	4 117 23	300	40	4
1	4 115 17	100	80	2	1	4 117 24	300	63	4
1	4 115 24	300	25	2	1	4 117 25	300	80	4
1	4 115 25	300	40	2	1	4 117 45	300 selective	40	4
1	4 115 26	300	63	2	1	4 117 46	300 selective	63	4
1	4 115 27	300	80	2	1	4 117 32	500	25	4
1	4 115 28	300	100	2	1	4 117 33	500	40	4
1	4 115 37	100 selective	100	2	1	4 117 34	500	63	4
1	4 115 43	300 selective	63	2	1	4 117 35	500	80	4
		A type					A type		
1	4 115 50	10	16	2	1	4 117 59	30	25	4
1	4 115 54	30	25	2	1	4 117 60	30	40	4
1	4 115 55	30	40	2	1	4 117 61	30	63	4
1	4 115 56	30	63	2	1	4 117 62	30	80	4
1	4 115 57	30	80	2	1	4 117 63	30	100	4
1	4 115 69	300	25	2	1	4 117 69	100	25	4
1	4 115 70	300	40	2	1	4 117 70	100	40	4
1	4 115 71	300	63	2	1	4 117 71	100	63	4
1	4 115 72	300	80	2	1	4 117 72	100	80	4
1	4 115 84	300 selective	63	2	1	4 117 73	100	100	4
		Hpi type					Hpi type		
1	4 115 90	30	25	2	1	4 117 79	300	25	4
1	4 115 91	30	40	2	1	4 117 80	300	40	4
1	4 115 92	30	63	2	1	4 117 81	300	63	4
		B type					B type		
		Accept auxiliary contact Cat.No 4 062 59 only (p. 44)					Accept auxiliary contact Cat.No 4 062 59 only (p. 44)		
1	4 118 42	30	40	4	1	4 117 83	300	100	4
1	4 118 43	30	63	4	1	4 118 00	300 selective	40	4
1	4 118 44	300	40	4	1	4 118 01	300 selective	63	4
1	4 118 45	300	63	4	1	4 117 89	500	25	4
							4-pole - 400 V~ - neutral on left-hand side		
							B type		
							Accept auxiliary contact Cat.No 4 062 59 only (p. 44)		
1	4 118 46	30	40	4	1	4 118 46	30	40	4
1	4 118 47	30	63	4	1	4 118 47	30	63	4
1	4 118 48	300	40	4	1	4 118 48	300	40	4
1	4 118 49	300	63	4	1	4 118 49	300	63	4

Auxiliaries, accessories and remote control **p. 44-45**



Isolating switches DX³-IS

technical characteristics

DX³-IS remote trip head isolating switches

Electrical characteristics

Thermal rating (Ith)	40 - 63 A	100 - 125 A
	1 module/pole	1.5 module/pole
Terminals	Cage	Cage
Connection	flexible	6 to 50 mm ²
	rigid	6 to 70 mm ²
Insulation voltage (Ui)	500 V ~	500 V ~
Impulse withstand voltage (Uimp)	6 kV	6 kV
Category of use ⁽¹⁾	AC 22A / AC 23A	100 A = AC 22A / AC 23A 125 A = AC 22A
Short time withstand current (Icw)	1000 A during 1 s 1700 A during 0.5 s	1000 A during 1 s 1500 A during 0.5 s
Short-circuit making capacity (Icm)	3000 A	1500 A
No. of electrical operations	15000	10000
Protection index	IP 2X wired	IP 2X wired

(1) test conditions according to IEC 60947-3
 AC 22 A: combined motor/resistor breaking with frequent operations
 AC 23 A: inductive motor breaking at In/2 with frequent operations

DX³-IS isolating switches

Electrical characteristics

Thermal rating (Ith)	16 - 40 A	40 - 63 A	100 - 125 A
	0.5 module/pole	1 module/pole	1 module/pole
Terminals	Cage	Cage	Cage
Connection	flexible	1.5 to 25 mm ²	4 to 35 mm ²
	rigid	1.5 to 16 mm ²	4 to 50 mm ²
Insulation voltage (Ui)	500 V ~	500 V ~	500 V ~
Impulse withstand voltage (Uimp)	6 kV	6 kV	6 kV
Category of use ⁽¹⁾	AC 22 A	AC 22 A	AC 22 A
Short time withstand current (Icw)	750 A	2000 A	2500 A
Short-circuit making capacity (Icm)	1500 A	3000 A	3700 A
No. of electrical operations	30000	20000	5000
Protection index	IP 2X wired	IP 2X wired	IP 2X wired

(1) test conditions according to IEC 60947-3
 AC 22 A: combined motor/resistor breaking with frequent operations

RCCBs DX³-ID

technical characteristics

DX³-ID - RCCBs (residual current circuit breakers)

Connection cross-section

RCCBs	Cable (mm ²)	
	Rigid	Flexible
Connection at top and bottom	50	35

AC type - Standard applications

AC type RCCBs detect sinusoidal AC residual currents. In the majority of cases (standard applications), they are used for AC current detection at 50 Hz.

A type - Specific applications: dedicated lines

In addition to the characteristics of AC type RCCBs, A type RCCBs also detect pulsating DC residual currents. They are used whenever fault currents are not sinusoidal. They are particularly suitable for the following specific applications: hobs, washing machines or materials that may produce DC fault currents, speed drives with frequency inverters, etc.

G type - Same applications like A type

Meet the requirements of ÖVE/ÖNORM E 8601 standard

B type - Specific applications: dedicated lines

In addition to the characteristics of A type RCCBs, B type RCCBs also detect smooth DC residual currents. They are used whenever fault currents are not sinusoidal. They are particularly suitable for the following specific applications: speed drives and inverters for supplying motors for pumps, lifts, textile machines, machine tools, photovoltaic installations, call centres, medical equipment, etc.

Hpi type - Special applications

Type Hpi RCCBs are devices which offer additional immunity to unwanted tripping which significantly exceeds the level required by the standard. They are also able to detect AC and DC residual currents (A type). Operation between - 25 °C and + 40 °C. They are used in special applications where:

- Loss of information is potentially damaging, e.g. power supply lines for computer equipment (banks, equipment on military bases, flight reservation centres, etc.)
- Loss of operation is potentially damaging (automated machinery, medical equipment, freezer cable, etc.)

They are also used:

- On sites where there is an increased risk of lightning strikes
- On sites where cables are subject to high levels of interference (use of fluorescents, etc.)
- On sites where very long cables are used
- For spaces with chlorinated swimming pool-type atmosphere

RCBOs DX™ 10000

residual current circuit breakers from 10 A to 45 A - AC type



6 064 15

Technical characteristics **see e-catalogue**

Breaking capacity:

10000 - IEC 61009-1

• AC type : detect AC component faults

Pack	Cat.Nos	Single pole - 230 V~		
		Blue neutral leads		
		AC Type 30 mA		
		Nominal rating In (A)		Number of modules
1	6 064 10	10		1
1	6 064 11	16		1
1	6 064 12	20		1
1	6 064 13	25		1
1	6 064 14	32		1
1	6 064 15	45		1

MANUAL SUPPLY INVERTORS, FRONT EXTERNAL HANDLES

Discover the products

Thanks to the new manual supply invertors you can improve the continuity of service of your installation.

The front external rotary handles allow a better control of the modular devices without opening the door of the enclosure.

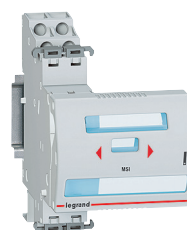

Manual supply inverter p. 45

MANUAL SUPPLY INVERTOR (MSI)

For 2P, 3P and 4P DX³ and MCBs and remote trip isolating switches
For manually switching between mains and an alternative power supply

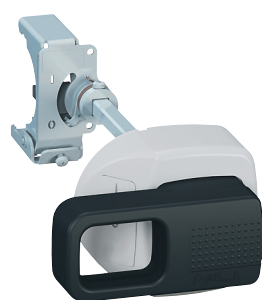

Front external rotary handle p. 45

EXTERNAL HANDLE

For all DX³, TX³ and RX³ devices from 2P upwards.
Allow the manual control of the modular devices without opening the enclosure
Available in two versions : with black or yellow & red handle



Other products:

DX³ add-on modules with integrated measuring unit **p. 43**



Installation principle
see e-catalogue



RCBOs DX³ 6000 - 6 kA - residual current circuit breakers from 2 A to 40 A - AC, A and Hpi types



4 110 13

Technical characteristics [see e-catalogue](#)

Conform to IEC 61009-1

Breaking capacity:

6000 - IEC 61009-1 - 6 kA / IEC 60947

- AC type : detect AC component faults
 - A type : detect AC and DC component faults
 - Hpi type (High immunity) : detect AC and DC component faults
- Enhanced immunity to unwanted tripping in disturbed environments
Can be equipped with DX³ signalling and remote tripping auxiliaries and motorised controls (p. 44-45)

Pack	Cat.Nos		Single pole + neutral - 230 V _~ (neutral on right-hand side)	
			Compatible with fork type supply busbars	
			AC Type 10 mA	
			Nominal rating I _n (A)	Number of modules
1	B curve 4 109 07	C curve 4 109 05	16	2
			AC Type 30 mA	
1		4 110 07	2	2
1		4 110 08	3	2
1		4 110 09	4	2
1		4 110 10	6	2
1	4 109 18	4 110 11	10	2
1	4 109 19	4 110 12	13	2
1	4 109 20	4 110 13	16	2
1	4 109 21	4 110 14	20	2
1	4 109 22	4 110 15	25	2
1	4 109 23	4 110 16	32	2
1	4 109 24	4 110 17	40	2
			AC Type 300 mA	
1		4 110 33	10	2
1		4 110 35	16	2
			A Type 10 mA	
1	4 109 47	4 110 43	16	2
			A Type 30 mA	
1	4 109 62	4 110 58	6	2
1	4 109 63	4 110 59	10	2
1	4 109 64	4 110 60	13	2
1	4 109 65	4 110 61	16	2
1	4 109 66	4 110 62	20	2
1	4 109 67	4 110 63	25	2
1	4 109 68	4 110 64	32	2
1	4 109 69	4 110 65	40	2
			A Type 300 mA	
1		4 110 81	10	2
1		4 110 83	16	2
1		4 110 84	20	2
			Hpi Type 30 mA	
1		4 111 02	6	2
1		4 111 03	10	2
1		4 111 04	13	2
1		4 111 05	16	2
1		4 111 06	20	2
1		4 111 07	25	2
1		4 111 08	32	2
1		4 111 09	40	2

RCBOs DX³ 6000 - 10 kA - residual current circuit breakers from 10 A to 63 A - AC, A and Hpi types



4 110 68



4 111 49

Technical characteristics [see e-catalogue](#)

Conform to IEC 61009-1

Breaking capacity:

6000 - IEC 61009-1 - 10 kA / IEC 60947-2

- AC type : detect AC component faults
 - A type : detect AC and DC component faults
 - Hpi type (High immunity) : detect AC and DC component faults
- Enhanced immunity to unwanted tripping in disturbed environments
Can be equipped with DX³ signalling and remote tripping auxiliaries and motorised controls (p. 44-45)

Pack	Cat.Nos		Single pole + neutral - 230 V _~ (neutral on left-hand side)	
			Compatible with fork type supply busbars	
			A Type 30 mA	
			Nominal rating I _n (A)	Number of modules
1	C curve 4 110 66		10	2
1			13	2
1			16	2
1			20	2
			2-pole - 230 V_~	
			Compatible with prong-type and fork type supply busbars	
			AC Type 10 mA	
			Nominal rating I _n (A)	Number of modules
1	C curve 4 111 49		10	4
1			16	4
1			20	4
			AC Type 30 mA	
1			10	4
1			16	4
1			20	4
1			25	4
1			32	4
1			40	4
1			50	4
1			63	4
			AC Type 300 mA	
1			10	4
1			16	4
1			20	4
1			25	4
1			32	4
1			40	4
1			50	4
1			63	4

RCBOs DX³ **6000** - 10 kA - residual current circuit breakers from 10 A to 63 A - AC, A and Hpi types (continued)

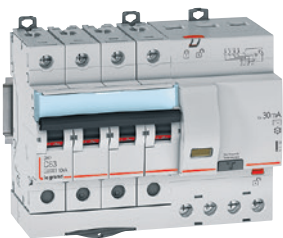

4 111 92



4 112 41

RCBOs DX³ **10000** - 16 kA - residual current circuit breakers from 6 A to 40 A - AC and A types



4 113 12

Technical characteristics [see e-catalogue](#)

Conform to IEC 61009-1

Breaking capacity:

6000 - IEC 61009-1 - 10 kA / IEC 60947-2

- AC type : detect AC component faults
- A type : detect AC and DC component faults
- Hpi type (High immunity) : detect AC and DC component faults

Enhanced immunity to unwanted tripping in disturbed environments

Can be equipped with DX³ signalling and remote tripping auxiliaries and motorised controls (p. 44-45)

Pack	Cat.Nos	4-pole - 400 V \sim	
		4-module RCBOs are compatible with both prong-type and fork type supply busbars 7-module RCBOs are compatible with prong-type supply busbars only	
		AC Type 30 mA	
	C curve	Nominal rating I _n (A)	Number of modules
1	4 111 85	10	4
1	4 111 86	16	4
1	4 111 87	20	4
1	4 111 88	25	4
1	4 111 89	32	4
1	4 111 90	40	7
1	4 111 91	50	7
1	4 111 92	63	7
		AC Type 300 mA	
1	4 112 04	10	4
1	4 112 05	16	4
1	4 112 06	20	4
1	4 112 07	25	4
1	4 112 08	32	4
1	4 112 09	40	7
1	4 112 10	50	7
1	4 112 11	63	7
		A Type 30 mA	
1	4 112 33	10	4
1	4 112 34	16	4
1	4 112 35	20	4
1	4 112 36	25	4
1	4 112 37	32	4
		A Type 300 mA	
1	4 112 38	10	4
1	4 112 39	16	4
1	4 112 40	20	4
1	4 112 41	25	4
1	4 112 42	32	4
		Hpi Type 30 mA	
1	4 112 44	16	4
1	4 112 45	20	4
1	4 112 46	25	4
1	4 112 47	32	4

Technical characteristics [see e-catalogue](#)

Conform to IEC 61009-1

Breaking capacity:

10000 - IEC 61009-1 - 16 kA / IEC 60947-2

- AC type : detect AC component faults
- A type : detect AC and DC component faults
- G type : detect AC and DC component faults as per ÖVE/ONORM E 8601

Enhanced immunity to unwanted tripping in disturbed environments

Can be equipped with DX³ signalling and remote tripping auxiliaries and motorised controls (p. 44-45)

Pack	Cat.Nos		Single pole + neutral - 230 V \sim (neutral on right-hand side)	
			Compatible with fork type supply busbars	
			AC Type 10 mA	
	B curve	C curve	Nominal rating I _n (A)	Number of modules
1	4 109 71	4 109 78	10	2
1	4 109 72	4 109 79	16	2
1	4 109 73	4 109 80	20	2
1	4 109 74	4 109 81	25	2
1	4 109 75	4 109 82	32	2
1	4 109 76	4 109 83	40	2
			A Type 30 mA	
1	4 112 85	4 112 93	6	2
1	4 112 86	4 112 94	10	2
1	4 112 87	4 112 95	13	2
1	4 112 88	4 112 96	16	2
1	4 112 89	4 112 97	20	2
1	4 112 90	4 112 98	25	2
1	4 112 91	4 112 99	32	2
1	4 112 92	4 113 00	40	2
			G Type 30 mA	
1	4 113 02	4 113 10	10	2
1	4 113 03	4 113 11	13	2
1	4 113 04	4 113 12	16	2
1	4 113 05	4 113 13	20	2
1	4 113 06	4 113 14	25	2

For detailed dimensions, [see e-catalogue](#)



MCBs DX³ [6000] - 10 kA

thermal magnetic MCBs from 0.5 A to 63 A - B and C curves



4 074 35



4 077 42



4 078 02

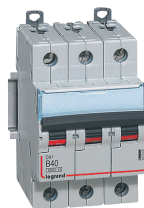

4 075 65

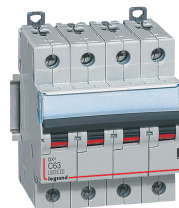

4 079 34

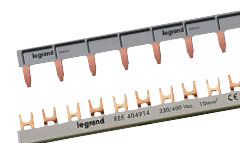

Technical characteristics [see e-catalogue](#)

Conform to IEC 60898-1

Compatible with both prong-type and fork type supply busbars (except single pole + neutral 1 module MCBs)

Breaking capacity:

[6000] - IEC 60898-1 - 400 V \sim

10 kA - IEC 60947-2 - 400 V \sim

Can be equipped with DX³ signalling and remote tripping auxiliaries, motorised controls (p. 44-45) and add-on modules (p. 42)

Pack	Cat.Nos		Single pole 230/400 V \sim		Pack	Cat.Nos		3-pole 400 V \sim	
	B curve	C curve	Nominal rating I _n (A)	Number of modules		B curve	C curve	Nominal rating I _n (A)	Number of modules
1	4 074 25	4 076 62	1	1	1	4 075 54	4 078 51	1	3
1	4 074 26	4 076 63	2	1	1	4 075 55	4 078 52	2	3
1	4 074 27	4 076 64	3	1	1	4 075 56	4 078 53	3	3
1	4 074 28	4 076 65	4	1	1	4 075 57	4 078 54	4	3
1	4 074 29	4 076 66	6	1	1	4 075 58	4 078 55	6	3
10	4 074 30	4 076 68	10	1	1	4 075 59	4 078 57	10	3
1	4 074 31	4 076 69	13	1	1	4 075 60	4 078 58	13	3
10	4 074 32	4 076 70	16	1	1	4 075 61	4 078 59	16	3
1	4 074 33	4 076 71	20	1	1	4 075 62	4 078 60	20	3
1	4 074 34	4 076 72	25	1	1	4 075 63	4 078 61	25	3
1	4 074 35	4 076 73	32	1	1	4 075 64	4 078 62	32	3
1	4 074 36	4 076 74	40	1	1	4 075 65	4 078 63	40	3
1	4 074 37	4 076 75	50	1	1	4 075 66	4 078 64	50	3
1	4 074 38	4 076 76	63	1	1	4 075 67	4 078 65	63	3

	B curve	C curve	Nominal rating I _n (A)	Number of modules		B curve	C curve	Nominal rating I _n (A)	Number of modules
1	4 074 67	4 077 33	0.5	1	1	4 076 17	4 079 20	1	4
1	4 074 68	4 077 34	1	1	1	4 076 18	4 079 21	2	4
1	4 074 69	4 077 35	2	1	1	4 076 19	4 079 22	3	4
1	4 074 70	4 077 36	3	1	1	4 076 20	4 079 23	4	4
1	4 074 71	4 077 37	4	1	1	4 076 21	4 079 24	6	4
1	4 074 72	4 077 38	6	1	1	4 076 22	4 079 26	10	4
1	4 074 73	4 077 40	10	1	1	4 076 23	4 079 27	13	4
1	4 074 74	4 077 41	13	1	1	4 076 24	4 079 28	16	4
1	4 074 75	4 077 42	16	1	1	4 076 25	4 079 29	20	4
10	4 074 76	4 077 43	20	1	1	4 076 26	4 079 30	25	4
1	4 074 77	4 077 44	25	1	1	4 076 27	4 079 31	32	4
1	4 074 78	4 077 45	32	1	1	4 076 28	4 079 32	40	4
1	4 074 79	4 077 46	40	1	1	4 076 29	4 079 33	50	4
1					1	4 076 30	4 079 34	63	4

	B curve	C curve	Nominal rating I _n (A)	Number of modules
1	4 075 02	4 077 92	1	2
1	4 075 03	4 077 93	2	2
1	4 075 04	4 077 94	3	2
1	4 075 05	4 077 95	4	2
1	4 075 06	4 077 96	6	2
11.5	4 075 07	4 077 98	10	2
1	4 075 08	4 077 99	13	2
11.5	4 075 09	4 078 00	16	2
1	4 075 10	4 078 01	20	2
1	4 075 11	4 078 02	25	2
1	4 075 12	4 078 03	32	2
1	4 075 13	4 078 04	40	2
1	4 075 14	4 078 05	50	2
1	4 075 15	4 078 06	63	2

MCBs DX³ [6000] - 10 kA

thermal magnetic MCBs from 0.5 A to 63 A - D curve



4 079 67



4 080 33

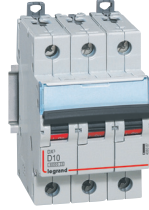

4 080 87

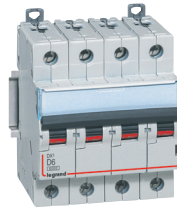

4 081 43

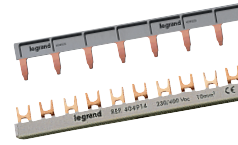

Technical characteristics **see e-catalogue**

Conform to IEC 60898-1

Compatible with both prong-type and fork type supply busbars

Breaking capacity:

[6000] - IEC 60898-1 - 400 V~

10 kA - IEC 60947-2 - 400 V~

Can be equipped with DX³ signalling and remote tripping auxiliaries, motorised controls (p. 44-45) and add-on modules (p. 42)

Pack Cat.Nos Single pole 230/400 V~

Pack	Cat.Nos	Nominal rating I _n (A)	Number of modules
	D curve		
1	4 079 62	0.5	1
1	4 079 63	1	1
1	4 079 64	2	1
1	4 079 65	3	1
1	4 079 66	4	1
1	4 079 67	6	1
1	4 079 69	10	1
1	4 079 70	13	1
1	4 079 71	16	1
1	4 079 72	20	1
1	4 079 73	25	1
1	4 079 74	32	1
1	4 079 75	40	1
1	4 079 76	50	1
1	4 079 77	63	1

Pack Cat.Nos 3-pole 400 V~

Pack	Cat.Nos	Nominal rating I _n (A)	Number of modules
	D curve		
1	4 080 80	0.5	3
1	4 080 82	2	3
1	4 080 83	3	3
1	4 080 84	4	3
1	4 080 85	6	3
1	4 080 87	10	3
1	4 080 88	13	3
1	4 080 89	16	3
1	4 080 90	20	3
1	4 080 91	25	3
1	4 080 92	32	3
1	4 080 93	40	3
1	4 080 94	50	3
1	4 080 95	63	3

Pack Cat.Nos 2-pole 230/400 V~

Pack	Cat.Nos	Nominal rating I _n (A)	Number of modules
	D curve		
1	4 080 22	0.5	2
1	4 080 23	1	2
1	4 080 24	2	2
1	4 080 25	3	2
1	4 080 26	4	2
1	4 080 27	6	2
1	4 080 29	10	2
1	4 080 30	13	2
1	4 080 31	16	2
1	4 080 32	20	2
1	4 080 33	25	2
1	4 080 34	32	2
1	4 080 35	40	2
1	4 080 36	50	2
1	4 080 37	63	2

Pack Cat.Nos 4-pole 400 V~

Pack	Cat.Nos	Nominal rating I _n (A)	Number of modules
	D curve		
1	4 081 43	6	4
1	4 081 45	10	4
1	4 081 46	13	4
1	4 081 47	16	4
1	4 081 48	20	4
1	4 081 49	25	4
1	4 081 50	32	4
1	4 081 51	40	4
1	4 081 52	50	4
1	4 081 53	63	4

MCBs DX³ 10000 - 16 kA

thermal magnetic MCBs from 0.5 A to 125 A - B and C curves

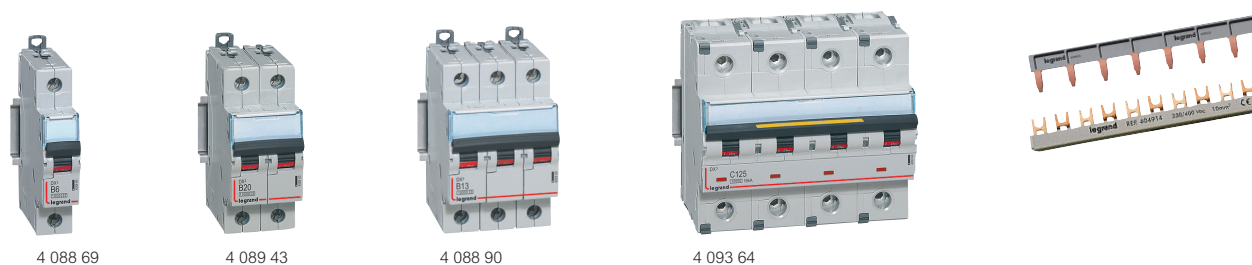

Technical characteristics **see e-catalogue**

Conform to IEC 60898-1

Compatible with both prong-type and fork type supply busbars (except 80 A, 100 A and 125 A MCBs)

Breaking capacity:

10000 - IEC 60898-1 - 400 V \sim

16 kA - IEC 60947-2 - 400 V \sim

Can be equipped with DX³ signalling and remote tripping auxiliaries, motorised controls (p. 44-45) and add-on modules (p. 42-43)

Single pole 230/400 V \sim				3-pole 400 V \sim					
Pack	Cat.Nos		Nominal rating In (A)	Number of modules	Pack	Cat.Nos		Nominal rating In (A)	Number of modules
	B curve	C curve				B curve	C curve		
1	4 088 64	4 091 06	0.5	1	1	4 089 83	4 092 46	0.5	3
1	4 088 65	4 091 07	1	1	1	4 089 84	4 092 47	1	3
1	4 088 66	4 091 08	2	1	1	4 089 85	4 092 48	2	3
1	4 088 67	4 091 09	3	1	1	4 089 86	4 092 49	3	3
1	4 088 68	4 091 10	4	1	1	4 089 87	4 092 50	4	3
1	4 088 69	4 091 11	6	1	1	4 089 88	4 092 51	6	3
1 10	4 088 70	4 091 12	10	1	1	4 089 89	4 092 52	10	3
1	4 088 71	4 091 13	13	1	1	4 089 90	4 092 53	13	3
1 10	4 088 72	4 091 14	16	1	1	4 089 91	4 092 54	16	3
1	4 088 73	4 091 15	20	1	1	4 089 92	4 092 55	20	3
1	4 088 74	4 091 16	25	1	1	4 089 93	4 092 56	25	3
1	4 088 75	4 091 17	32	1	1	4 089 94	4 092 57	32	3
1	4 088 76	4 091 18	40	1	1	4 089 95	4 092 58	40	3
1	4 088 77	4 091 19	50	1	1	4 089 96	4 092 59	50	3
1	4 088 78	4 091 20	63	1	1	4 089 97	4 092 60	63	3
1		4 091 40	80	1.5	1	4 090 15	4 092 80	80	4.5
1		4 091 41	100	1.5	1	4 090 16	4 092 81	100	4.5
1		4 091 42	125	1.5	1		4 092 82	125	4.5

2-pole 230/400 V \sim				4-pole 400 V \sim					
	B curve	C curve	Nominal rating In (A)	Number of modules		B curve	C curve	Nominal rating In (A)	Number of modules
1	4 089 34	4 091 94	0.5	2	1	4 090 57	4 093 28	0.5	4
1	4 089 35	4 091 95	1	2	1	4 090 58	4 093 29	1	4
1	4 089 36	4 091 96	2	2	1	4 090 59	4 093 30	2	4
1	4 089 37	4 091 97	3	2	1	4 090 60	4 093 31	3	4
1	4 089 38	4 091 98	4	2	1	4 090 61	4 093 32	4	4
1	4 089 39	4 091 99	6	2	1	4 090 62	4 093 33	6	4
1	4 089 40	4 092 00	10	2	1	4 090 63	4 093 34	10	4
1	4 089 41	4 092 01	13	2	1	4 090 64	4 093 35	13	4
1	4 089 42	4 092 02	16	2	1	4 090 65	4 093 36	16	4
1	4 089 43	4 092 03	20	2	1	4 090 66	4 093 37	20	4
1	4 089 44	4 092 04	25	2	1	4 090 67	4 093 38	25	4
1	4 089 45	4 092 05	32	2	1	4 090 68	4 093 39	32	4
1	4 089 46	4 092 06	40	2	1	4 090 69	4 093 40	40	4
1	4 089 47	4 092 07	50	2	1	4 090 70	4 093 41	50	4
1	4 089 48	4 092 08	63	2	1	4 090 71	4 093 42	63	4
1	4 089 66	4 092 28	80	3	1	4 090 89	4 093 62	80	6
1	4 089 67	4 092 29	100	3	1	4 090 90	4 093 63	100	6
1		4 092 30	125	3	1		4 093 64	125	6

MCBs DX³ 10000 - 16 kA

thermal magnetic MCBs from 2 A to 125 A - D curve



Technical characteristics **see e-catalogue**

Conform to IEC 60898-1

Compatible with both prong-type and fork type supply busbars (except 80 A, 100 A and 125 A MCBs)

Breaking capacity:

10000 - IEC 60898-1 - 400 V \sim

16 kA - IEC 60947-2 - 400 V \sim

Can be equipped with DX³ signalling and remote tripping auxiliaries, motorised controls (p. 44-45) and add-on modules (p. 42-43)

Pack	Cat.Nos	Single pole 230/400 V \sim		Pack	Cat.Nos	3-pole 400 V \sim	
	D curve	Nominal rating In (A)	Number of modules		D curve	Nominal rating In (A)	Number of modules
1	4 094 25	2	1	1	4 094 92	2	3
1	4 094 28	6	1	1	4 094 95	6	3
1	4 094 30	10	1	1	4 094 97	10	3
1	4 094 32	16	1	1	4 094 99	16	3
1	4 094 33	20	1	1	4 095 00	20	3
1	4 094 34	25	1	1	4 095 01	25	3
1	4 094 35	32	1	1	4 095 02	32	3
1	4 094 36	40	1	1	4 095 03	40	3
1	4 094 37	50	1	1	4 095 04	50	3
1	4 094 38	63	1	1	4 095 05	63	3
				1	4 095 06	80	4.5
				1	4 095 07	100	4.5
				1	4 095 08	125	4.5
	D curve	Nominal rating In (A)	Number of modules		D curve	Nominal rating In (A)	Number of modules
1	4 094 44	2	2	1	4 095 26	2	4
1	4 094 47	6	2	1	4 095 29	6	4
1	4 094 49	10	2	1	4 095 31	10	4
1	4 094 51	16	2	1	4 095 33	16	4
1	4 094 52	20	2	1	4 095 34	20	4
1	4 094 53	25	2	1	4 095 35	25	4
1	4 094 54	32	2	1	4 095 36	32	4
1	4 094 55	40	2	1	4 095 37	40	4
1	4 094 56	50	2	1	4 095 38	50	4
1	4 094 57	63	2	1	4 095 39	63	4
1	4 094 58	80	3	1	4 095 40	80	6
1	4 094 59	100	3	1	4 095 41	100	6
1	4 094 60	125	3	1	4 095 42	125	6

MCBs DX³ - 16 kA - direct current

thermal magnetic MCBs from 0.5 A to 63 A

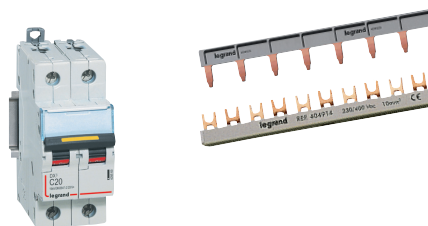

4 095 69

Technical characteristics [see e-catalogue](#)

Operating voltage from 12 V_{DC} to 500 V_{DC}

Breaking capacity:

16 kA - IEC 60947-2 - 230 V_{DC}

10 kA - IEC 60947-2 - 440 V_{DC}

6 kA - IEC 60947-2 - 500 V_{DC}

Magnetic threshold from 5 to 7 In

Can be equipped with DX³ signalling and remote tripping auxiliaries and motorised controls (p. 44-45)

Pack	Cat.Nos	Direct current circuit breakers		
		Nominal rating In (A)	Number of poles protected	Number of modules
1	4 095 59	0,5	2	2
1	4 095 60	1	2	2
1	4 095 61	1,6	2	2
1	4 095 62	2	2	2
1	4 095 63	3	2	2
1	4 095 64	4	2	2
1	4 095 65	6	2	2
1	4 095 66	8	2	2
1	4 095 67	10	2	2
1	4 095 68	16	2	2
1	4 095 69	20	2	2
1	4 095 70	25	2	2
1	4 095 71	32	2	2
1	4 095 72	40	2	2
1	4 095 73	50	2	2
1	4 095 74	63	2	2

For detailed dimensions, [see e-catalogue](#)



MCBs DX³ - 25 kA

thermal magnetic MCBs from 2 A to 125 A - B and C curves

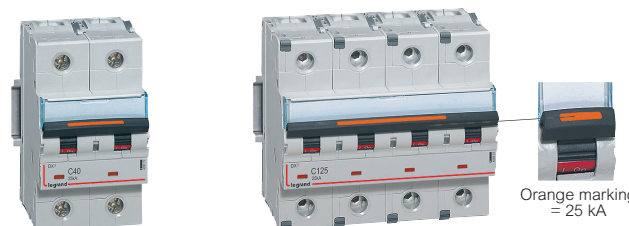

4 097 72

4 098 03

Orange marking = 25 kA

Technical characteristics [see e-catalogue](#)

Breaking capacity:

25 kA - IEC 60947-2 - 400 V_{AC}

Can be equipped with DX³ signalling and remote tripping auxiliaries and motorised controls (p. 44-45)

Pack	Cat.Nos	Single pole 230/400 V _{AC}		Nominal rating In (A)	Number of modules
		C curve			
1	4 097 52			2	1
1	4 097 53			6	1
1	4 097 54			10	1
1	4 097 55			16	1
1	4 097 56			20	1
1	4 097 57			25	1
1	4 097 58			32	1,5
1	4 097 59			40	1,5
1	4 097 60			50	1,5
1	4 097 61			63	1,5
1	4 097 62			80	1,5
1	4 097 63			100	1,5
1	4 097 64			125	1,5

Pack	Cat.Nos	2-pole 230/400 V _{AC}		Nominal rating In (A)	Number of modules
		B curve	C curve		
1	4 097 65			2	2
1	4 097 66			6	2
1	4 097 15			10	2
1	4 097 16			16	2
1	4 097 17			20	2
1	4 097 18			25	2
1	4 097 19			32	2
1	4 097 20			40	3
1	4 097 21			50	3
1	4 097 22			63	3
1	4 097 75			80	3
1	4 097 76			100	3
1	4 097 77			125	3

Pack	Cat.Nos	3-pole 400 V _{AC}		Nominal rating In (A)	Number of modules
		B curve	C curve		
1	4 097 78			2	3
1	4 097 79			6	3
1	4 097 28			10	3
1	4 097 29			16	3
1	4 097 30			20	3
1	4 097 31			25	3
1	4 097 32			32	4,5
1	4 097 33			40	4,5
1	4 097 34			50	4,5
1	4 097 35			63	4,5
1	4 097 88			80	4,5
1	4 097 89			100	4,5
1	4 097 90			125	4,5

Pack	Cat.Nos	4-pole 400 V _{AC}		Nominal rating In (A)	Number of modules
		B curve	C curve		
1	4 097 91			2	4
1	4 097 92			6	4
1	4 097 41			10	4
1	4 097 42			16	4
1	4 097 43			20	4
1	4 097 44			25	4
1	4 097 45			32	6
1	4 097 46			40	6
1	4 097 47			50	6
1	4 097 48			63	6
1	4 097 49			80	6
1	4 097 50			100	6
1	4 097 51			125	6

MCBs DX³ - 25 kA

thermal magnetic MCBs from 1 A to 125 A - D and Z curves



Technical characteristics [see e-catalogue](#)

Breaking capacity:
25 kA - IEC 60947-2 - 400 V_~
Can be equipped with DX³ signalling and remote tripping auxiliaries and motorised controls (p. 44-45)

Pack	Cat.Nos		Single pole 230/400 V _~	
	D curve	Z curve	Nominal rating I _n (A)	Number of modules
1		4 098 96	1	1
1	4 098 04	4 098 97	2	1
1		4 098 98	3	1
1	4 098 05	4 099 00	6	1
1	4 098 06	4 099 01	10	1
1	4 098 07	4 099 02	16	1
1	4 098 08	4 099 03	20	1
1	4 098 09	4 099 04	25	1
1	4 098 10		32	1.5
1	4 098 11		40	1.5
1	4 098 12		50	1.5
1	4 098 13		63	1.5
1	4 098 14		80	1.5
1	4 098 15		100	1.5
1	4 098 16		125	1.5

Pack	Cat.Nos		2-pole - 230/400 V _~	
	D curve	Z curve	Nominal rating I _n (A)	Number of modules
1	4 098 17	4 099 08	2	2
1		4 099 09	3	2
1	4 098 18	4 099 11	6	2
1	4 098 19	4 099 12	10	2
1	4 098 20	4 099 13	16	2
1	4 098 21	4 099 14	20	2
1	4 098 22		25	2
1	4 098 23		32	2
1	4 098 24		40	3

Pack	Cat.Nos		3 pole 400 V _~	
	D curve	Z curve	Nominal rating I _n (A)	Number of modules
1	4 098 30		2	3
1		4 099 20	3	3
1	4 098 31	4 099 22	6	3
1	4 098 32	4 099 23	10	3
1	4 098 33	4 099 24	16	3
1	4 098 34	4 099 25	20	3
1	4 098 35	4 099 26	25	3
1	4 098 36		32	4.5
1	4 098 37		40	4.5
1	4 098 38		50	4.5
1	4 098 39		63	4.5
1	4 098 40		80	4.5
1	4 098 41		100	4.5
1	4 098 42		125	4.5

Pack	Cat.Nos		4 pole 400 V _~	
	D curve	Z curve	Nominal rating I _n (A)	Number of modules
1	4 098 43		2	4
1	4 098 44		6	4
1	4 098 45	4 099 34	10	4
1	4 098 46	4 099 35	16	4
1	4 098 47	4 099 36	20	4
1	4 098 48	4 099 37	25	4
1	4 098 49		32	6
1	4 098 50		40	6
1	4 098 51		50	6
1	4 098 52		63	6
1	4 098 53		80	6
1	4 098 54		100	6
1	4 098 55		125	6

MCBs DX³ - 25 kA

magnetic release only (MA) MCBs from 1.6 A to 63 A

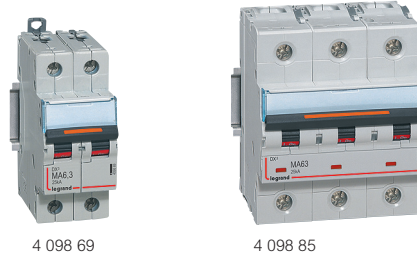

Technical characteristics [see e-catalogue](#)

Breaking capacity:
25 kA - IEC 60947-2 - 400 V_~
Can be equipped with DX³ signalling and remote tripping auxiliaries and motorised controls (p. 44-45)

Pack	Cat.Nos		2-pole 230/400 V _~	
	MA curve	Nominal rating I _n (A)	Number of modules	
1	4 098 66	1.6	2	
1	4 098 67	2.5	2	
1	4 098 68	4	2	
1	4 098 69	6.3	2	
1	4 098 70	10	2	
1	4 098 71	12.5	3	
1	4 098 72	16	3	
1	4 098 73	25	3	

Pack	Cat.Nos		3-pole 400 V _~	
	MA curve	Nominal rating I _n (A)	Number of modules	
1	4 098 76	1.6	3	
1	4 098 77	2.5	3	
1	4 098 78	4	3	
1	4 098 79	6.3	3	
1	4 098 80	10	3	
1	4 098 81	12.5	4.5	
1	4 098 82	16	4.5	
1	4 098 83	25	4.5	
1	4 098 84	40	4.5	
1	4 098 85	63	4.5	

Pack	Cat.Nos		4-pole 400 V _~	
	MA curve	Nominal rating I _n (A)	Number of modules	
1	4 098 86	1.6	4	
1	4 098 87	2.5	4	
1	4 098 88	4	4	
1	4 098 89	6.3	4	
1	4 098 90	10	4	
1	4 098 91	12.5	6	
1	4 098 92	16	6	
1	4 098 93	25	6	
1	4 098 94	40	6	
1	4 098 95	63	6	

MCBs DX³ - 36 kA

thermal magnetic MCBs from 10 A to 80 A - C curve



MCBs DX³ - 50 kA

thermal magnetic MCBs from 10 A to 63 A - B and C curves



Technical characteristics [see e-catalogue](#)

Breaking capacity:
36 kA - IEC 60947-2 - 400 V_~
Can be equipped with DX³ auxiliaries and accessories (p. 44)

Pack	Cat.Nos	2-pole - 230/400 V _~	
	C curve	Nominal rating In (A)	Number of modules
1	4 100 07	10	3
1	4 100 08	16	3
1	4 100 09	20	3
1	4 100 10	25	3
1	4 100 11	32	3
1	4 100 12	40	3
1	4 100 13	50	3
1	4 100 14	63	3
1	4 100 15	80	3

Pack	Cat.Nos	3-pole - 400 V _~	
	C curve	Nominal rating In (A)	Number of modules
1	4 100 20	10	4.5
1	4 100 21	16	4.5
1	4 100 22	20	4.5
1	4 100 23	25	4.5
1	4 100 24	32	4.5
1	4 100 25	40	4.5
1	4 100 26	50	4.5
1	4 100 27	63	4.5
1	4 100 28	80	4.5

Pack	Cat.Nos	4-pole - 400 V _~	
	C curve	Nominal rating In (A)	Number of modules
1	4 100 33	10	6
1	4 100 34	16	6
1	4 100 35	20	6
1	4 100 36	25	6
1	4 100 37	32	6
1	4 100 38	40	6
1	4 100 39	50	6
1	4 100 40	63	6
1	4 100 41	80	6

Technical characteristics [see e-catalogue](#)

Breaking capacity:
50 kA - IEC 60947-2 - 400 V_~
Can be equipped with DX³ auxiliaries and accessories (p. 44)

Pack	Cat.Nos	Single pole 230/400 V _~	
	C curve	Nominal rating In (A)	Number of modules
1	4 101 34	10	1.5
1	4 101 35	16	1.5
1	4 101 36	20	1.5
1	4 101 37	25	1.5
1	4 101 38	32	1.5
1	4 101 39	40	1.5
1	4 101 40	50	1.5
1	4 101 41	63	1.5

Pack	Cat.Nos	2-pole 230/400 V _~	
	B curve C curve	Nominal rating In (A)	Number of modules
1	4 100 97 4 101 47	10	3
1	4 100 98 4 101 48	16	3
1	4 100 99 4 101 49	20	3
1	4 101 00 4 101 50	25	3
1	4 101 01 4 101 51	32	3
1	4 101 02 4 101 52	40	3
1	4 101 53	50	3
1	4 101 54	63	3

Pack	Cat.Nos	3-pole 400 V _~	
	C curve	Nominal rating In (A)	Number of modules
1	4 101 60	10	4.5
1	4 101 61	16	4.5
1	4 101 62	20	4.5
1	4 101 63	25	4.5
1	4 101 64	32	4.5
1	4 101 65	40	4.5
1	4 101 66	50	4.5
1	4 101 67	63	4.5

Pack	Cat.Nos	4-pole 400 V _~	
	B curve C curve	Nominal rating In (A)	Number of modules
1	4 101 21 4 101 73	10	6
1	4 101 22 4 101 74	16	6
1	4 101 23 4 101 75	20	6
1	4 101 24 4 101 76	25	6
1	4 101 25 4 101 77	32	6
1	4 101 26 4 101 78	40	6
1	4 101 27 4 101 79	50	6
1	4 101 28 4 101 80	63	6

For detailed dimensions,
[see e-catalogue](#)



MCBs DX³ - 50 kA

thermal magnetic MCBs from 10 A to 63 A - D curve

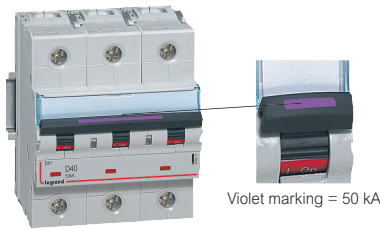

Violet marking = 50 kA

4 102 17

MCBs DX³ - 50 kA

magnetic release only (MA) MCBs from 1.6 A to 63 A

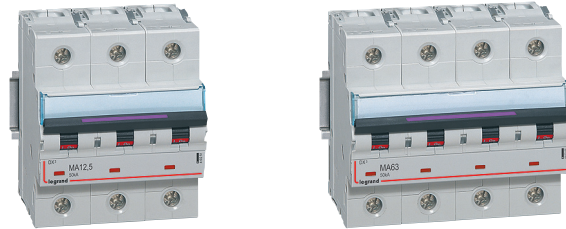

4 102 51

4 102 65

Technical characteristics [see e-catalogue](#)

Breaking capacity:
50 kA - IEC 60947-2 - 400 V \sim
Can be equipped with DX³ auxiliaries and accessories (p. 44)

Pack	Cat.Nos	Single pole 230/400 V \sim	
	D curve	Nominal rating In (A)	Number of modules
1	4 101 86	10	1.5
1	4 101 87	16	1.5
1	4 101 88	20	1.5
1	4 101 89	25	1.5
1	4 101 90	32	1.5
1	4 101 91	40	1.5
1	4 101 92	50	1.5
1	4 101 93	63	1.5

Pack	Cat.Nos	2-pole 230/400 V \sim	
	D curve	Nominal rating In (A)	Number of modules
1	4 101 99	10	3
1	4 102 00	16	3
1	4 102 01	20	3
1	4 102 02	25	3
1	4 102 03	32	3
1	4 102 04	40	3

Pack	Cat.Nos	3-pole 400 V \sim	
	D curve	Nominal rating In (A)	Number of modules
1	4 102 12	10	4.5
1	4 102 13	16	4.5
1	4 102 14	20	4.5
1	4 102 15	25	4.5
1	4 102 16	32	4.5
1	4 102 17	40	4.5
1	4 102 18	50	4.5
1	4 102 19	63	4.5

Pack	Cat.Nos	4-pole 400 V \sim	
	D curve	Nominal rating In (A)	Number of modules
1	4 102 25	10	6
1	4 102 26	16	6
1	4 102 27	20	6
1	4 102 28	25	6
1	4 102 29	32	6
1	4 102 30	40	6
1	4 102 31	50	6
1	4 102 32	63	6

Technical characteristics [see e-catalogue](#)

Breaking capacity:
50 kA - IEC 60947-2 - 400 V \sim
Can be equipped with DX³ auxiliaries and accessories (p. 44)

Pack	Cat.Nos	3-pole 400 V \sim	
	MA curve	Nominal rating In (A)	Number of modules
1	4 102 46	1.6	4.5
1	4 102 47	2.5	4.5
1	4 102 48	4	4.5
1	4 102 49	6.3	4.5
1	4 102 50	10	4.5
1	4 102 51	12.5	4.5
1	4 102 52	16	4.5
1	4 102 53	25	4.5
1	4 102 54	40	4.5
1	4 102 55	63	4.5

Pack	Cat.Nos	4-pole 400 V \sim	
	MA curve	Nominal rating In (A)	Number of modules
1	4 102 56	1.6	6
1	4 102 57	2.5	6
1	4 102 58	4	6
1	4 102 59	6.3	6
1	4 102 60	10	6
1	4 102 61	12.5	6
1	4 102 62	16	6
1	4 102 63	25	6
1	4 102 64	40	6
1	4 102 65	63	6

For detailed dimensions,
[see e-catalogue](#)



Add-on modules DX³

for 1 module/pole DX³ MCBs



4 104 01



4 104 71

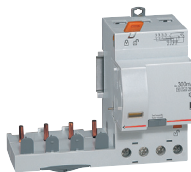

4 105 55

Technical characteristics [see e-catalogue](#)

Conform to IEC 61009-1

- AC type : detect AC components faults
- A type : detect AC and DC component faults
- Hpi type : detect faults with AC and DC components, increased immunity to false tripping

For mounting on the right-hand side of 1 module per pole DX³ MCBs

Pack	Cat.Nos	2-pole - 230 V _~			Pack	Cat.Nos	4-pole - 400 V _~		
		AC Type					AC Type		
		Sensitivity (mA)	Nominal rating In (A)	Number of modules			Sensitivity (mA)	Nominal rating In (A)	Number of modules
1	4 104 01	30	40	2	1	4 104 99	30	40	3
1	4 104 02	30	63	2	1	4 105 00	30	63	3
1	4 104 13	300	40	2	1	4 105 11	300	40	3
1	4 104 14	300	63	2	1	4 105 12	300	63	3
1	4 104 24	300 selective	63	2	1	4 105 20	300 selective	40	3
1	4 104 26	1000 selective	63	2	1	4 105 21	300 selective	63	3
		A Type					A Type		
1	4 104 28	30	40	2	1	4 105 25	30	40	3
1	4 104 29	30	63	2	1	4 105 26	30	63	3
1	4 104 10	100	40	2	1	4 105 08	100	40	3
1	4 104 11	100	63	2	1	4 105 09	100	63	3
1	4 104 31	300	40	2	1	4 105 28	300	40	3
1	4 104 32	300	63	2	1	4 105 29	300	63	3
		Hpi Type					Hpi Type		
1	4 104 34	30	40	2	1	4 105 31	300 selective	63	3
1	4 104 35	30	63	2					
1	4 104 46	30	40	2	1	4 105 33	30	40	3
1	4 104 57	300 selective	63	2	1	4 105 34	30	63	3
1	4 104 62	1000 selective	63	2	1	4 105 45	300	40	3
		3-pole - 400 V_~					3-pole - 400 V_~		
		AC Type					AC Type		
		Sensitivity (mA)	Nominal rating In (A)	Number of modules			Sensitivity (mA)	Nominal rating In (A)	Number of modules
1	4 104 71	30	40	3	1	4 105 46	300	63	3
1	4 104 72	30	63	3	1	4 105 46	300	63	3
1	4 104 74	300	40	3	1	4 105 55	300 selective	63	3
1	4 104 75	300	63	3	1	4 105 60	1000 selective	63	3
1	4 104 77	300 selective	63	3					
		A Type					A Type		
1	4 104 80	30	63	3					
1	4 104 83	300	63	3					
		Hpi Type					Hpi Type		
1	4 104 86	30	63	3					
1	4 104 89	300	63	3					
1	4 104 93	300 selective	63	3					

Add-on modules DX³

for 1.5 module/pole DX³ MCBs



Technical characteristics **see e-catalogue**

Conform to IEC 61009-1

- AC type : detect AC components faults
- Hpi type **Hpi**: detect faults with AC and DC components, increased immunity to false tripping

For mounting on the right-hand side of 1.5 module per pole DX³ MCBs

Pack	Cat.Nos	2-pole - 230 V \sim		
		Hpi Type Hpi		
		Sensitivity (mA)	Nominal rating In (A)	Number of modules
1	4 105 76	30	63	2
1	4 105 77	30	125	4
		Hpi Type Hpi adjustable		
1	4 105 83	from 300 to 1000	63	4
1	4 105 84	from 300 to 1000	125	4
		3-pole - 400 V\sim		
		Hpi Type Hpi		
		Sensitivity (mA)	Nominal rating In (A)	Number of modules
1	4 106 05	30	63	3
1	4 106 06	30	125	3
1	4 106 08	300	63	3
		Hpi Type Hpi adjustable		
1	4 106 11	from 300 to 1000	63	6
1	4 106 12	from 300 to 1000	125	6
		4-pole - 400 V\sim		
		AC Type		
		Sensitivity (mA)	Nominal rating In (A)	Number of modules
1	4 106 24	30	125	6
1	4 106 28	300	125	6
		Hpi Type Hpi		
1	4 106 36	30	63	3
1	4 106 37	30	125	6
1	4 106 40	300	63	3
		Hpi Type Hpi adjustable		
1	4 106 43	from 300 to 1000	63	6
1	4 106 44	from 300 to 1000	125	6
		4-pole 400 V\sim - Metering		
		LCD display For displaying active energy, instantaneous power and current per phase (A) consumption		
		Hpi type Hpi with integrated energy meter		
		Sensitivity (mA)	Nominal rating (A)	Number of modules
1	4 106 57	30 à 3000	63	7.5
1	4 106 58	30 à 3000	125	7.5
		4-pole 400 V\sim - Measurement		
		LCD display For displaying current per phase, voltage, frequency, active and reactive power, power factor, active and reactive energy consumption and harmonics		
		Hpi type Hpi with integrated measurement control unit		
		Sensitivity (mA)	Nominal rating (A)	Number of modules
1	4 106 59	30 à 3000	125	7.5

Add-on modules DX³

Compatibility MCBs/add-on modules

Breaking capacity	Curve	Number of poles	Add-on module for 1 module/pole MCBs	Add-on module for 1.5 module/pole MCBs
6000 / 10 kA	B, C, D	2P, 3P, 4P	All range	-
10000 / 16 kA	B, C, D	2P, 3P, 4P	In ≤ 63 A	In ≥ 80 A
25 kA	B, C, Z	3P, 4P	In ≤ 25 A	In ≥ 32 A
		2P	In ≤ 32 A	In ≥ 40 A
	D	3P, 4P	In ≤ 10 A	In ≥ 12,5 A
		2P	In ≤ 25 A	In ≥ 32 A
50 kA	B, C, D	2P, 3P, 4P	-	All range

Adjustable add-on modules, Hpi type

Easy to access settings on front panel with sealable transparent cover
Sensitivity: 300, 500 and 1000 mA
Time delay: instantaneous, selective (60 ms) or delayed (150 ms)

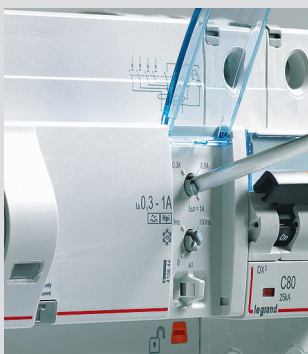

Hpi add-on modules with integrated metering unit or measurement control unit

Conform to standards EN 61009-1, EN 60947-2 and 61557-12 (PMD/DD/K55)

Electronic settings on the front panel
Sensitivity: 30, 300, 1000, 3000 mA
Time delay: instantaneous, or delayed (300 ms, 1 s, 3 s)

For integration in the EDMX³ display and supervision system with interface Cat.No 4 210 75 (p. 85), to feed back information and the status of the remote MCB.

Precision: EN 61557-12 Class 1

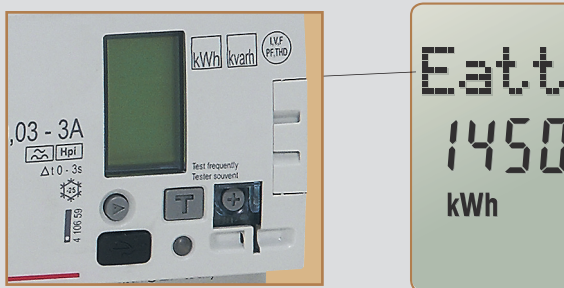

For detailed dimensions, **see e-catalogue**



Signalling and remote tripping auxiliaries DX³

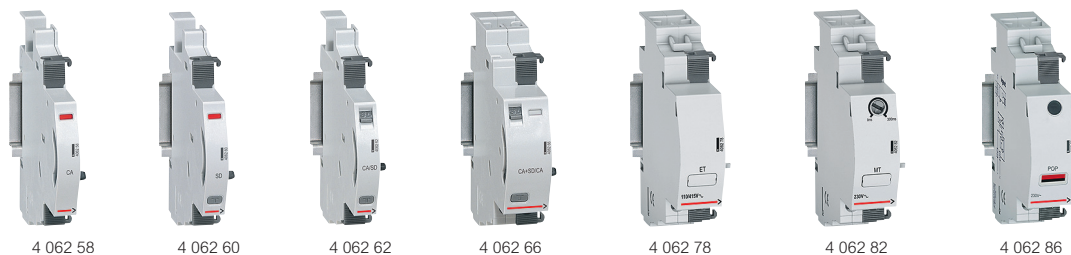

4 062 58 4 062 60 4 062 62 4 062 66 4 062 78 4 062 82 4 062 86

Pack	Cat.Nos	Signalling auxiliaries prong busbar adapted	Pack	Cat.Nos	Remote tripping auxiliaries	
1	4 062 58	<p>To fit on the left-hand side of DX³ and TX³ devices Maximum number of auxiliaries per device: - 3 signalling auxiliaries or - 2 signalling auxiliaries + 1 remote tripping auxiliary Allow insertion of the supply busbar, top side No tool required for joining together the auxiliary and the main device.</p> <p>Auxiliary contact 6 A - 250 V~ (changeover switch) For MCBs, RCBOs, RCCBs, isolating switches or remote trip isolating switches Indicates the position of the contacts of its associated device.</p>	Number of modules	0.5	<p>To fit on the left-hand side of DX³ and TX³ devices Maximum 1 remote tripping auxiliary per device Allow insertion of the supply busbar No tool required for joining together the auxiliary and the main device. For MCBs, RCBOs, RCCBs and remote trip isolating switches</p> <p>Current shunt trips For remote tripping of its associated device via a N/O push button</p>	Number of modules
1	4 062 60	<p>Fault signalling contact 6 A - 250 V~ (changeover switch) For MCBs, RCBOs, RCCBs, Indicates the fault tripping of its associated device</p>	0.5	1	4 062 76	1
1	4 062 62	<p>Auxiliary or fault signalling contact 6 A - 250 V~ (changeover switch) For MCBs, RCBOs, RCCBs Allows the choice between the two functions</p>	0.5	1	4 062 78	1
1	4 062 66	<p>Auxiliary + fault signalling contact or auxiliary contact + auxiliary contact 6 A - 250 V~ (changeover switch) For MCBs, RCBOs, RCCBs</p>	1	1	4 062 80	1
					4 062 82	1
					4 062 86	1
					4 062 87	1.5
					4 062 85	
1	4 062 50	<p>Signalling auxiliaries fork busbar adapted To fit on the left-hand side of DX³ and TX³ devices Maximum number of auxiliaries per device: - 3 signalling auxiliaries or - 2 signalling auxiliaries + 1 remote tripping auxiliary Allow insertion of supply busbar, bottom side No tool required for joining together the auxiliary and the main device.</p> <p>Auxiliary contact 6 A - 250 V~(changeover switch) For MCBs, RCBOs, RCCBs, isolating switch or remote trip isolating switch Indicates the position of the contacts of its associated device</p>	Number of modules	0.5	<p>Undervoltage releases For remote tripping of its associated device in case of mains voltage drop down or with the help of a N/C push button</p> <p>Power overvoltage protection (POP) Protects the circuit by tripping its associated device in case of overvoltage between phase and neutral. Tripping threshold: 275 V (eg. in case of neutral failure)</p> <p>Autonomous shunt trip for N/C push-button 230 V~ For remote tripping with positive security on a control circuit via a N/C push-button or emergency stop. Does not trigger its associated device in case of mains power failure (the trigger occurs only after a deliberate action of a N/C push-button). Supplied with battery Minimum working reserve: 60 hours (for remote tripping even if there is no supply voltage)</p> <p>Spare battery for autonomous shunt trip Cat.No 4 062 87</p>	
1	4 062 59	<p>6 A - 250 V~(changeover switch) For DX³-ID B type RCCBs (p. 29)</p>	0.5			
1	4 062 52	<p>Fault signalling contact 6 A - 250 V~ (changeover switch) For MCBs, RCBOs, RCCBs, Indicates the fault tripping of its associated device</p>	0.5			
1	4 062 56	<p>Auxiliary or fault signalling contact 6 A - 250 V~ (changeover switch) For MCBs, RCBOs, RCCBs Allows the choice between the two functions</p>	0.5			
1	4 062 64	<p>Auxiliary + fault signalling contact or auxiliary contact + auxiliary contact 6 A - 250 V~ (changeover switch) For MCB, RCBOs, RCCBs</p>	1			

Motorised controls DX³, STOP&GO automatic resetting

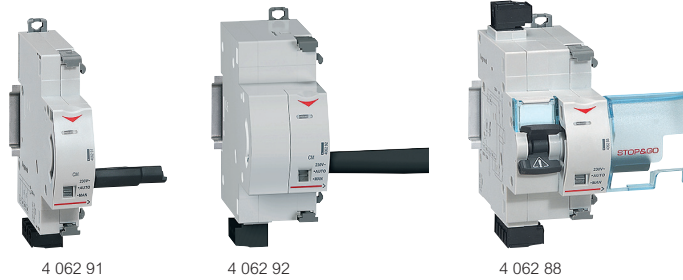

Pack	Cat.Nos	Motorised controls
		For remote control (opening and closing) of their associated device. To fit on the left-hand side of DX ³ and TX ³ devices For MCBs, RCBOs, RCCBs and remote trip isolating switches (from 1P to 4P) Can take one control auxiliary and one signalling auxiliary. No tool required for joining together the motorised control and the main device
		ON/OFF function - for 1 module / pole devices (In up to 63 A)
		Control voltage Number of modules
1	4 062 90	24-48 V~/= 1
1	4 062 91	230 V~/= 1
		ON/OFF function - for 1.5 module / pole devices (In up to 125 A)
1	4 062 92	230 V~/= 1
		ON/OFF + automatic resetting function - for 1 module / pole devices (In up to 63 A)
		Automatically resets the device to which it is associated, thus ensuring continuity of service
1	4 062 93	24-48 V~/= 2
1	4 062 95	230 V~/= 2
		STOP&GO automatic resetting
		For automatic resetting of 1 module per pole RCCBs and RCBOs up to 63 A STOP&GO is used in the event of unwanted tripping generated by temporarily electrical disturbances or other external events. Can take one control auxiliary and one signalling auxiliary. The signalling auxiliary must be placed between the STOP&GO and the control auxiliary. No tool required for assembling
		Automatic resetting function
		Control voltage No. of modules
1	4 062 88	230 V~/= 2
		Automatic resetting + periodic self-test function
1	4 062 89	230 V~/= 2

Manual supply inverter DX³ and accessories

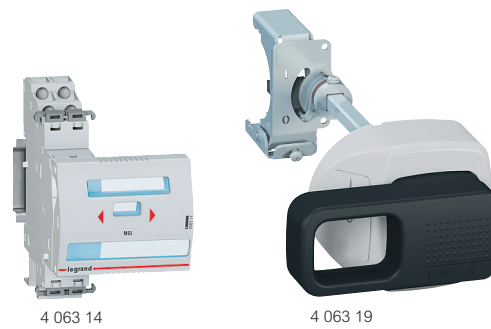

Pack	Cat.Nos	Manual supply inverter (MSI)
		For manually switching between the mains and an alternative power supply. Allow to restore power on pre-designated and/or critical circuits in case of a power failure of the main supply. For DX ³ MCBs and remote trip isolating switches Installation principle - see e-catalogue
1	4 063 14	For 2P 2-module devices
1	4 063 15	For 3P 3-module devices
1	4 063 16	For 4P 4-module devices
		Front external rotary handles
		Allow the manual control (open/close) of a modular device without opening the enclosure For all DX ³ devices from 2P upwards
1	4 063 19	Black handle
1	4 063 20	Yellow and red handle
		Wiring management accessories
		Insulating shields
1	4 063 05	For 1 module per pole MCBs For separation between the terminals of the MCB, when using high cross section cables
		Spacing unit with feedthrough
10	4 063 07	0.5 module Allows cables to run between two modular devices and creates an air channel in order to limit temperature rise
		Terminals for aluminium cables
1	4 063 10	For 1.5 module/pole MCBs up to 63 A
1	4 063 11	For 1.5 module/pole MCBs and remote trip isolating switches from 80 A to 125 A
		Safety and maintenance accessories
		Sealable screw covers
2	4 063 04	For 1 module per pole MCBs (set of 4)
1	4 063 12	For 1.5 module per pole MCBs (set of 4)
		Terminal shield
1	4 063 06	For 1.5 module/pole MCBs (set of 2)
		Padlocking
		To lock the handle of a modular device during maintenance
1	0 227 97	Large padlock, Ø6 mm, 50 mm length Supplied with two keys and labels
3	4 063 13	Small padlock, Ø5 mm
2	4 063 03	Support for one padlock (for small or large model) For locking the handle of the modular devices (MCBs, RCCBs, RCBOs or isolating switches) in OFF position

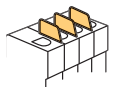

Performance of MCBs and auxiliaries

Breaking capacity in IT neutral earthing system

MCB single pole breaking capacity at 400 V according to IEC 60947-2

DX ³ 6000 10 kA	1P/2P/3P/4P	3 kA
DX ³ 10000 16 kA	1P/2P/3P/4P	4 kA
DX ³ 25 kA	1P/2P/3P/4P	6.25 kA
DX ³ 50 kA	1P/2P/3P/4P	12.5 kA

Breaking capacity in the event of short-circuit to earth and insulation voltage

	1P/2P/3P/4P 230/400 V~ MCBs			
	DX ³ 6000 10 kA	DX ³ 10000 16 kA	DX ³ 25 kA	DX ³ 50 kA
Icn1	10000 A	16000 A	25000 A	50000 A
Ui	500 V	500 V	500 V	500 V

Icn 1: Breaking capacity on 1 pole for multipole MCBs in the event of short-circuit to earth

Ui: Rated insulation voltage

Terminal connection cross-sections (mm²)

	Copper cable	
	Rigid	Flexible
DX ³ 6000 10 kA	35	25
DX ³ 10000 16 kA	70	50
DX ³ 80 to 125 A	70	50
DX ³ 25 kA	50	35
DX ³ 36 kA, DX ³ 50 kA and add-on modules	50	35
Auxiliaries	2.5	2.5

MCB tripping curves

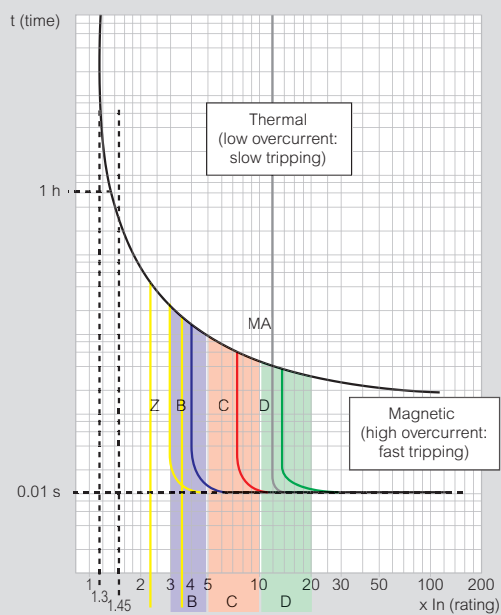

Curves	Magnetic threshold settings
Z	2.4 to 3.6 I _n
B	3 to 5 I _n
C	5 to 10 I _n
D	10 to 14 I _n (10 to 20 acc. to the stds)
MA	12 to 14 I _n

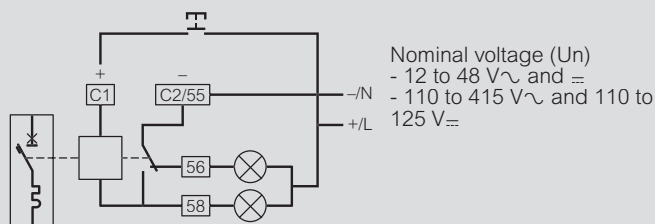

Consumption	Umin.	Umax.
12 to 48 V	522 mA	2610 mA
110 to 415 V	69 mA	259 mA

Undervoltage releases

Pull-in voltage $\geq 0.55 U_n$
Tripping time: 100 to 400 ms $\pm 10\%$ (adjustable)
Power consumption: 24 V~ and =: 0.1 VA
48 V~ and =: 0.2 VA
230 V~: 1 VA

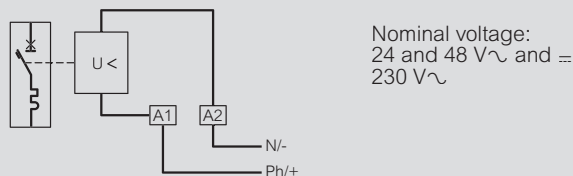

Stand-alone releases for N/C push-buttons

Min. and max. operating voltage: 196 to 250 V~
Power consumption: 1.4 VA

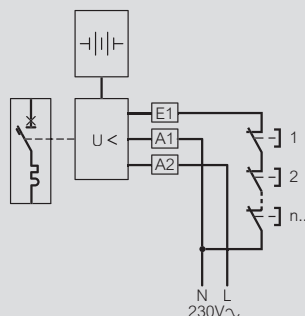

Signalling auxiliaries

Umin.: 24 V~/= and Imin.: 5 mA

Compatibility between auxiliaries on 1 module/pole devices

1 module / pole device (auxiliary on the left side)	1st auxiliary	2nd auxiliary	3rd auxiliary
1st auxiliary	4 062 .. 50/52/56/58/60/ 62/66/76/78/80/ 82/84/86/87	-	-
2nd auxiliary	4 062 .. 50/52/56/ 58/60/62	4 062 .. 50/52/56/58/60/62/76/ 78/80/82/84/86/87	-
	4 062 .. 64/66/	4 062 .. 50/52/56/58/60/62/64/ 66/76/78/80/82/84/86/87	
3rd auxiliary	4 062 .. 50/52/56/ 58/60/62	4 062 .. 50/52/56/58/60/62	4 062 .. 76/78/80/82/ 84/86/87
	4 062 .. 64/66	4 062 .. 50/52/56/58/ 60/62/64/66	

Compatibility between auxiliaries on 1.5 module/pole devices

1.5 module / pole device (auxiliary on the left side)	1st auxiliary	2nd auxiliary	3rd auxiliary
1st auxiliary	4 062 .. 50/52/56/58/60/ 62/66/76/78/80/ 82/84/86/87	-	-
2nd auxiliary	4 062 .. 50/52/56/ 58/60/62	4 062 .. 50/52/56/58/60/62/	-
	4 062 .. 64/66/	4 062 .. 50/52/56/58/60/62/64/ 66/76/78/80/82/84/86/87	
3rd auxiliary	4 062 .. 64/66	4 062 .. 64/66	4 062 .. 76/78/80/82/ 84/86/87

Performance of add-on modules

AC type - Standard applications

Detection of 50-60 Hz AC residual currents

A type - Specific applications: dedicated lines

In addition to the characteristics of AC type add-on modules, A type add-on modules also detect residual currents with DC components. They are used whenever the fault currents are not sinusoidal. They are particularly suitable for the following dedicated line applications:

- On circuits where class 1 equipment may produce fault currents with DC components, such as variable speed drives with frequency inverter, etc.

Hpi type - Special applications

Hpi add-on modules, with additional immunity to false tripping, which is much higher than the level required by the standard, detect residual currents with AC and DC components (A type), operate between - 25°C and + 40°C, and are used in the following special cases:

- When loss of data would be detrimental, such as computer equipment power supply lines (banks, military instrumentation, airline reservation centres, etc.)

- When loss of operation would be detrimental (automated machines, medical instrumentation, freezer lines, etc.)

- In places where there is a high risk of lightning strikes

- On sites with lines subject to considerable interference (use of fluorescent lights, etc)

- On sites with very long lines

Special case of continuity of service

In certain locations where no staff are present and in which continuity of service is particularly important, false tripping of MCBs is not permitted (isolated telephone/TV or radio substations, pumping stations, etc.)

Combining an Hpi RCBO with a motorised control and a STOP & GO recloser provides optimum continuity of service

B type

In addition to the characteristics of A type RCDs, B type RCDs also detect smooth DC residual currents

They are used whenever fault currents are not sinusoidal

They are particularly suitable for the following specific applications : speed drives and inverters for supplying motors for pumps, lifts, textile machines, machine tools, photovoltaic installations, call centres, medical equipment, etc.

Average residual current performance curves

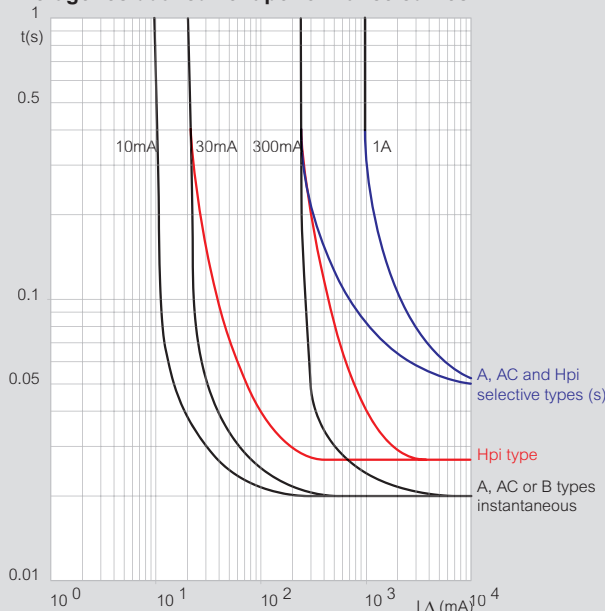

Residual current breaking capacity of DX³ add-on modules

I Δ m according to EN 61009-1

AC, A and Hpi add-on modules

DX ³ add-on modules used with an MCB	I Δ m
DX ³ (1 mod./pole)	25 kA \leq 25 A (B, C, Z curves) 25 kA \leq 10 A (D, MA curves)
DX ³ (1.5 mod./pole)	16 kA (80 to 125 A) 25 kA \geq 32 A (B, C, Z curves) 25 kA \geq 12.5 A (D, MA curves) 36 kA 50 kA

DPX³ and DX³

back-up tables¹ (in kA)

Breaking capacity (enhanced by cascading) in three-phase networks (+N) 400/415 V according to IEC 60947-2 (kA)

Back-up protection allows to increase the breaking capacity of a circuit breaker by coordinating it with another protection device, placed upstream. This coordination makes it possible to use a protection device with a breaking capacity which is lower than the maximum prospective short-circuit current at its installation point⁽¹⁾.

MCBs/MCCBs upstream		DX ³ 10000 16 kA B, C and D curves	DX ³ 25 kA B, C and D curves	DX ³ 36 kA C curve	DX ³ 50 kA B, C and D curves	DPX ³ 160 with or without e.l.c.b.s				DPX ³ 250 with or without e.l.c.b.s			
MCBs downstream		10 to 125 A	10 to 125 A	10 to 80 A	10 to 63 A	16 kA 16 to 160 A	25 kA 16 to 160 A	36 kA 16 to 160 A	50 kA 16 to 160 A	25 kA 40 to 250 A	36 kA 40 to 250 A	50 kA 40 to 250 A	70 kA 40 to 250 A
DX ³ 6000 / 10 kA B, C and D curves	≤ 20 A	16 kA	25 kA	36 kA	50 kA	16 kA	25 kA	25 kA	25 kA	25 kA	25 kA	25 kA	25 kA
	25 A	16 kA	25 kA	36 kA	50 kA	16 kA	25 kA	25 kA	25 kA	25 kA	25 kA	25 kA	25 kA
	32 A	16 kA	25 kA	36 kA	50 kA	16 kA	25 kA	25 kA	25 kA	25 kA	25 kA	25 kA	25 kA
	40 A	16 kA	25 kA	36 kA	50 kA	16 kA	25 kA	25 kA	25 kA	25 kA	25 kA	25 kA	25 kA
	50 A	16 kA	25 kA	36 kA	50 kA	16 kA	25 kA	25 kA	25 kA	25 kA	25 kA	25 kA	25 kA
DX ³ 10000 / 16 kA B, C and D curves	≤ 20 A	-	25 kA	36 kA	50 kA	-	25 kA	25 kA	25 kA	25 kA	25 kA	25 kA	25 kA
	25 A	-	25 kA	36 kA	50 kA	-	25 kA	25 kA	25 kA	25 kA	25 kA	25 kA	25 kA
	32 A	-	25 kA	36 kA	50 kA	-	25 kA	25 kA	25 kA	25 kA	25 kA	25 kA	25 kA
	40 A	-	25 kA	36 kA	50 kA	-	25 kA	25 kA	25 kA	25 kA	25 kA	25 kA	25 kA
	50 A	-	25 kA	36 kA	50 kA	-	25 kA	25 kA	25 kA	25 kA	25 kA	25 kA	25 kA
	63 A	-	25 kA	36 kA	-	-	25 kA	25 kA	25 kA	25 kA	25 kA	25 kA	25 kA
	80 and 100 A	-	-	-	-	-	25 kA	25 kA	25 kA	25 kA	25 kA	25 kA	25 kA
125 A	-	-	-	-	-	25 kA	25 kA	25 kA	25 kA	25 kA	25 kA	25 kA	
DX ³ 25 kA B, C curves	≤ 25 A	-	-	36 kA	50 kA	-	-	36 kA	36 kA	-	36 kA	36 kA	36 kA
	32 to 50 A	-	-	36 kA	50 kA	-	-	36 kA	36 kA	-	36 kA	36 kA	36 kA
	63 to 80 A	-	-	-	-	-	-	36 kA	36 kA	-	36 kA	36 kA	36 kA
	100 and 125 A	-	-	-	-	-	-	36 kA	36 kA	-	36 kA	36 kA	36 kA
DX ³ 25 kA D and MA curves	≤ 10 A	-	-	36 kA	50 kA	-	-	36 kA	36 kA	-	36 kA	36 kA	36 kA
	16 to 63 A	-	-	36 kA	50 kA	-	-	36 kA	36 kA	-	36 kA	36 kA	36 kA
DX ³ 36 kA C curve	10 to 63 A	-	-	-	50 kA	-	-	-	50 kA	-	-	50 kA	50 kA
	80 A	-	-	-	-	-	-	-	50 kA	-	-	50 kA	50 kA
DX ³ 50 kA B, C, D and MA curves	≤ 63 A	-	-	-	-	-	-	-	-	-	-	-	70 kA

Breaking capacity (enhanced by cascading) in three-phase networks (+N) 230/240 V according to IEC 60947-2 (kA)

Breaking capacity of the combination between a Phase+Neutral or 2P MCB (connected between phase and neutral in 230V) downstream to a 2P or 4P MCB, for TT, TNS or TNC earthing systems.

MCBs/MCCBs upstream		DX ³ Ph+N (1 mod.)			DX ³ 4500 6 kA C curve	DX ³ 6000 10 kA B, C and D curves	DX ³ 10000 16 kA B, C and D curves		DX ³ 25 kA B, C and D curves		DX ³ 36 kA C curve		DX ³ 50 kA B and C curves		DX ³ 50 kA D curve	
MCBs downstream		DNX ³ 4500 6 kA C curve	DX ³ 6000 10 kA C curve	DX ³ 10000 16 kA C curve	≤ 40 A	≤ 63 A	≤ 32 A	40 to 125 A	≤ 32 A	40 to 125 A	≤ 32 A	40 to 80 A	≤ 32 A	40 to 63 A	≤ 32 A	40 to 63 A
IP+N in 1 mod. MCBs DX ³ 6000 10 kA B and C curves	≤ 10 A	-	-	16 kA	-	15 kA	25 kA	25 kA	40 kA	40 kA	70 kA	70 kA	75 kA	75 kA	75 kA	75 kA
	16 and 20 A	-	-	16 kA	-	15 kA	25 kA	25 kA	40 kA	40 kA	70 kA	70 kA	75 kA	75 kA	75 kA	75 kA
	25 A	-	-	-	-	15 kA	25 kA	25 kA	40 kA	40 kA	70 kA	70 kA	75 kA	75 kA	75 kA	75 kA
	32 A	-	-	-	-	15 kA	25 kA	25 kA	40 kA	40 kA	70 kA	70 kA	75 kA	75 kA	75 kA	75 kA
DX ³ 10000 16 kA C curve	40 A	-	-	-	-	15 kA	-	25 kA	-	40 kA	-	70 kA	-	75 kA	-	75 kA
	≤ 10 A	-	-	-	-	25 kA	16 kA	16 kA	25 kA	25 kA	36 kA	36 kA	50 kA	50 kA	50 kA	50 kA
	16 and 20 A	-	-	-	-	25 kA	16 kA	16 kA	25 kA	25 kA	36 kA	36 kA	50 kA	50 kA	50 kA	50 kA
DX ³ 6000 10 kA B, C and D curves	≤ 20 A	-	-	-	-	-	32 kA	25 kA	40 kA	40 kA	70 kA	70 kA	75 kA	75 kA	75 kA	75 kA
	25 to 40 A	-	-	-	-	-	-	25 kA	-	40 kA	-	70 kA	-	75 kA	-	75 kA
	50 A	-	-	-	-	-	-	25 kA	-	40 kA	-	70 kA	-	-	-	-
	63 A	-	-	-	-	-	-	25 kA	-	40 kA	-	70 kA	-	-	-	-
DX ³ 10000 16 kA B, C and D curves	≤ 20 A	-	-	-	-	-	-	-	40 kA	40 kA	70 kA	70 kA	75 kA	75 kA	75 kA	75 kA
	25 to 40 A	-	-	-	-	-	-	-	-	40 kA	-	70 kA	-	75 kA	-	75 kA
	50 and 63 A	-	-	-	-	-	-	-	-	40 kA	-	70 kA	-	75 kA	-	75 kA
80 to 125 A	-	-	-	-	-	-	-	-	-	-	-	-	-	-	-	
DX ³ 25 kA B and C curves	≤ 25 A	-	-	-	-	-	-	-	-	-	70 kA	70 kA	75 kA	75 kA	75 kA	75 kA
	32 to 125 A	-	-	-	-	-	-	-	-	-	-	70 kA	-	75 kA	-	75 kA
DX ³ 25 kA D and MA curves	≤ 10 A	-	-	-	-	-	-	-	-	-	70 kA	70 kA	75 kA	75 kA	75 kA	75 kA
	16 to 63 A	-	-	-	-	-	-	-	-	-	70 kA	70 kA	75 kA	75 kA	75 kA	75 kA
DX ³ 36 kA C curve	10 to 80 A	-	-	-	-	-	-	-	-	-	-	-	85 kA	75 kA	75 kA	75 kA
DX ³ 50 kA B, C, D and MA curves	≤ 63 A	-	-	-	-	-	-	-	-	-	-	-	-	-	-	-

1 : All the values apply also to RCBOs. Nominal rating and magnetic threshold of the upstream MCB must be superior to the ones of the downstream MCB

Note : In accordance with its policy of continuous improvement the Company reserves the right to change values without notice.

	DPX ³ 630		DPX ³ 1600
	36 kA 160 to 630 A	70 kA 160 to 630 A	50 kA and 70 kA 630 to 1600 A
	25 kA	25 kA	25 kA
	25 kA	25 kA	20 kA
	25 kA	25 kA	15 kA
	20 kA	20 kA	15 kA
	16 kA	16 kA	12.5 kA
	16 kA	16 kA	12.5 kA
	25 kA	25 kA	25 kA
	25 kA	25 kA	20 kA
	25 kA	25 kA	16 kA
	20 kA	20 kA	16 kA
	20 kA	20 kA	16 kA
	20 kA	20 kA	16 kA
	20 kA	20 kA	16 kA
	16 kA	16 kA	16 kA
	30 kA	30 kA	30 kA
	36 kA	36 kA	36 kA
	36 kA	36 kA	36 kA
	30 kA	30 kA	30 kA
	30 kA	30 kA	30 kA
	36 kA	36 kA	36 kA
	-	50 kA	50 kA
	-	36 kA	36 kA
	-	70 kA	70 kA

	DPX ³ 160 with or without e.l.c.b.s				DPX ³ 250 with or without e.l.c.b.s				DPX ³ 630		DPX ³ 1600
	16 kA 16 to 160 A	25 kA 16 to 160 A	36 kA 16 to 160 A	50 kA 16 to 160 A	25 kA 40 to 250 A	36 kA 40 to 250 A	50 kA 40 to 250 A	70 kA 40 to 250 A	36 kA 160 to 630 A	70 kA 160 to 630 A	50 kA and 70 kA 630 to 1600 A
	22 kA	30 kA	30 kA	30 kA	30 kA	30 kA	30 kA	30 kA	25 kA	25 kA	25 kA
	22 kA	30 kA	30 kA	30 kA	30 kA	30 kA	30 kA	30 kA	25 kA	25 kA	25 kA
	22 kA	25 kA	25 kA	25 kA	25 kA	25 kA	25 kA	25 kA	20 kA	20 kA	20 kA
	16 kA	16 kA	16 kA	16 kA	16 kA	16 kA	16 kA	16 kA	10 kA	10 kA	10 kA
	16 kA	16 kA	16 kA	16 kA	16 kA	16 kA	16 kA	16 kA	10 kA	10 kA	10 kA
	22 kA	30 kA	30 kA	30 kA	30 kA	30 kA	30 kA	30 kA	25 kA	25 kA	25 kA
	22 kA	30 kA	30 kA	30 kA	30 kA	30 kA	30 kA	30 kA	25 kA	25 kA	25 kA
	25 kA	40 kA	40 kA	40 kA	40 kA	40 kA	40 kA	40 kA	40 kA	40 kA	40 kA
	28 kA	40 kA	40 kA	40 kA	40 kA	40 kA	40 kA	40 kA	40 kA	40 kA	40 kA
	28 kA	40 kA	40 kA	40 kA	40 kA	40 kA	40 kA	40 kA	25 kA	25 kA	12.5 kA
	28 kA	40 kA	40 kA	40 kA	40 kA	40 kA	40 kA	40 kA	25 kA	25 kA	12.5 kA
	-	40 kA	40 kA	40 kA	40 kA	40 kA	40 kA	40 kA	40 kA	40 kA	40 kA
	-	40 kA	40 kA	40 kA	40 kA	40 kA	40 kA	40 kA	40 kA	40 kA	25 kA
	-	40 kA	40 kA	40 kA	40 kA	40 kA	40 kA	40 kA	40 kA	40 kA	25 kA
	-	40 kA	40 kA	40 kA	40 kA	40 kA	40 kA	40 kA	25 kA	25 kA	25 kA
	-	-	70 kA	70 kA	-	70 kA	70 kA	70 kA	30 kA	30 kA	30 kA
	-	-	70 kA	70 kA	-	70 kA	70 kA	70 kA	70 kA	70 kA	70 kA
	-	-	70 kA	70 kA	-	70 kA	70 kA	70 kA	70 kA	30 kA	30 kA
	-	-	70 kA	70 kA	-	70 kA	70 kA	70 kA	70 kA	70 kA	70 kA
	-	-	-	75 kA	-	-	75 kA	75 kA	-	75 kA	75 kA
	-	-	-	-	-	-	-	140 kA	-	140 kA	140 kA

DPX³ and DX³ upstream / DX³ downstream

selectivity limits (kA)

Downstream MCB	Upstream MCB																					
	In (A)	DX ³ 25 kA, DX ³ 36 kA, DX ³ 50 kA and DX ³ 100000 / 16 kA (80 to 125 A)								DX ³ 25 kA, DX ³ 50 kA and DX ³ 100000 / 16 kA (80 to 125 A)						DPX ³ 160 with or without e.l.c.b.s 16 kA, 25 kA, 36 kA and 50 kA						
		C curve								D curve												
DX ³ 6000 / 10 kA (1P+N) DX ³ 10000 / 16 kA (1P+N) B and C curves 1P+N in 1 mod.¹	≤ 6	0,7	1,2	1,5	3	4	T	T	0,7	1,2	1,5	3	4	T	T	T	T	T	T	T		
	10	0,5	0,7	1	1,8	3	5	T	0,5	0,7	1	1,8	3	5	T	T	T	T	T	T		
	13	0,5	0,7	1	1,8	3	5	T	0,5	0,7	1	1,8	3	5	T	T	T	T	T	T		
	16	0,3	0,5	0,7	1,3	2	3,6	5,5	0,4	0,5	0,7	1,3	2	3,6	5,5	T	T	T	T	T		
	20	0,3	0,4	0,5	1	1,6	3	4	0,384	0,48	0,6	1	1,6	3	4	T	T	T	T	T		
	25	0,24	0,4	0,5	0,8	1,3	2,4	3,3	0,384	0,48	0,6	0,8	1,3	2,4	3,3	T	T	T	T	T		
	32	-	0,3	0,5	0,6	1	1,8	2,7	-	0,48	0,6	0,756	1,1	1,45	2,7	T	T	T	T	T		
	40	-	-	0,4	0,6	0,8	1,6	2,4	-	-	0,6	0,756	1	1,25	2,4	-	T	T	T	T		
	50	0,7	1,2	1,5	3	4	T	T	0,7	1,2	1,5	3	4	T	T	12	T	T	T	T		
	63	0,5	0,7	1	1,8	3	5	T	0,5	0,7	1	1,8	3	5	T	7	7	T	T	T		
DX ³ 6000 / 10 kA DX ³ 10000 / 16 kA B and C curves	16	0,3	0,5	0,7	1,3	2	3,6	5,5	0,384	0,5	0,7	1,3	2	3,6	5,5	6	6	6	6	6		
	20	0,3	0,4	0,5	1	1,6	3	4	0,384	0,48	0,6	1	1,6	3	4	5	5	5	6	6		
	25	0,24	0,4	0,5	0,8	1,3	2,4	3,3	0,384	0,48	0,6	0,8	1,3	2,4	3,3	4,5	4,5	4,5	4,5	8,5		
	32	-	0,3	0,5	0,6	1	1,8	2,7	-	0,48	0,6	0,756	1,1	1,45	2,7	-	3	4	4	7	10	
	40	-	-	0,4	0,6	0,8	1,6	2,4	-	-	0,6	0,756	1	1,25	2,4	-	3	3	3	6	8	
	50	-	-	-	0,5	0,8	0,9	1,7	-	-	-	0,756	0,95	1,2	1,7	-	-	3	3	5,5	7	
	63	-	-	-	-	0,65	0,9	1,2	-	-	-	-	0,95	1,2	1,5	-	-	3	3	5	6	
	80	-	-	-	-	-	0,6	0,75	-	-	-	-	-	1,2	1,5	-	-	-	-	5	6	
	100	-	-	-	-	-	-	0,75	-	-	-	-	-	-	1,5	-	-	-	-	5	6	
	125	-	-	-	-	-	-	-	-	-	-	-	-	-	-	-	-	-	-	-	3	
DX ³ 10000 / 16 kA B and C curves	≤ 6	0,7	1,2	1,5	3	4	T	T	0,5	1,2	1,5	3	4	T	T	T	T	T	T	T		
	10	0,5	0,7	1	1,8	3	5	T	0,4	0,7	1	1,8	3	5	T	7,5	7,5	T	T	T		
	16	0,3	0,5	0,7	1,3	2	3,6	5,5	0,384	0,5	0,7	1,3	2	3,6	5,5	6	6	6	6	6		
	20	0,3	0,4	0,5	1	1,6	3	4	0,384	0,48	0,6	1	1,6	3	4	5	5	6	6	6		
	25	-	-	0,5	0,8	1,3	2,4	3,3	-	0,48	0,6	0,8	1,3	2,4	3,3	4,5	4,5	4,5	4,5	8,5		
	32	-	-	-	0,6	1	1,8	2,7	-	0,48	0,6	0,756	1,1	1,45	2,7	-	3	4	4	7	10	
	40	-	-	-	-	0,8	1,6	2,4	-	-	0,6	0,756	1	1,25	2,4	-	3	3	3	6	10	
	50	-	-	-	-	-	0,9	1,7	-	-	-	0,756	0,95	1,2	1,7	-	-	3	3	5,5	10	
	63	-	-	-	-	-	-	1,2	-	-	-	-	-	0,95	1,2	1,5	-	-	3	5	10	
	80	-	-	-	-	-	-	-	-	-	-	-	-	-	1,2	1,5	-	-	-	5	10	
DX ³ 25 kA B and C curves	100	-	-	-	-	-	-	-	-	-	-	-	-	-	1,5	-	-	-	-	5		
	125	-	-	-	-	-	-	-	-	-	-	-	-	-	-	-	-	-	-	3		
	≤ 6	0,7	1,2	1,5	3	4	T	T	0,5	1,2	1,5	3	4	T	T	T	T	T	T	T		
	10	0,5	0,7	1	1,8	3	5	T	0,4	0,7	1	1,8	3	5	T	T	T	T	T	T		
	16	0,3	0,5	0,7	1,3	2	3,6	5,5	0,384	0,5	0,7	1,3	2	3,6	5,5	T	T	T	T	T		
	20	0,3	0,4	0,5	1	1,6	3	4	0,384	0,48	0,6	1	1,6	3	4	T	T	T	T	T		
	25	0,24	0,4	0,5	0,8	1,3	2,4	3,3	-	0,48	0,6	0,8	1,3	2,4	3,3	T	T	T	T	T		
	32	-	0,3	0,5	0,6	1	1,8	2,7	-	0,48	0,6	0,756	1,1	1,45	2,7	-	T	T	T	T		
	40	-	-	0,4	0,6	0,8	1,6	2,4	-	-	0,6	0,756	1	1,25	2,4	-	T	T	T	T		
	50	-	-	-	0,5	0,8	0,9	1,7	-	-	-	0,756	0,95	1,2	1,7	-	4	4	5	10	10	
DX ³ 25 kA D curve	63	-	-	-	-	0,65	0,9	1,2	-	-	-	-	0,95	1,2	1,5	-	-	3	5	10	10	
	80	-	-	-	-	-	0,6	0,75	-	-	-	-	-	1,2	1,5	-	-	-	-	5	6	
	100	-	-	-	-	-	-	0,75	-	-	-	-	-	-	1,5	-	-	-	-	5	6	
	125	-	-	-	-	-	-	-	-	-	-	-	-	-	-	-	-	-	-	-	3	
	≤ 6	0,7	1,2	1,5	3	4	T	T	0,5	1,2	1,5	3	4	T	T	T	T	T	T	T	T	
	10	0,5	0,7	1	1,8	3	5	T	0,4	0,7	1	1,8	3	5	T	T	T	T	T	T	T	
	16	0,3	0,5	0,7	1,3	2	3,6	5,5	0,384	0,5	0,7	1,3	2	3,6	5,5	T	T	T	T	T	T	
	20	-	0,4	0,5	1	1,6	3	4	0,384	0,48	0,6	1	1,6	3	4	T	T	T	T	T	T	
	25	-	-	0,5	0,8	1,3	2,4	3,3	0,384	0,48	0,6	0,8	1,3	2,4	3,3	T	T	T	T	T	T	
	32	-	-	-	0,6	1	1,8	2,7	-	0,48	0,6	0,756	1,1	1,45	2,7	-	T	T	T	T	T	
DX ³ MA 25 kA	40	-	-	-	-	0,8	1,6	2,4	-	-	0,6	0,756	1	1,25	2,4	-	T	T	T	T		
	63	-	-	-	-	-	-	1,2	-	-	-	-	0,95	1,2	1,5	-	-	3	5	10	10	
	10	0,5	0,7	1	1,8	3	-	-	-	0,5	0,7	1	1,8	-	-	-	T	T	T	T	T	
	16	0,3	0,5	0,7	1,3	2	-	-	-	0,384	0,5	0,7	1,3	-	-	-	T	T	T	T	T	
	20	0,3	0,4	0,5	1	1,6	-	-	-	0,384	0,48	0,6	1	-	-	-	T	T	T	T	T	
	25	0,24	0,4	0,5	0,8	1,3	-	-	-	0,384	0,48	0,6	0,8	-	-	-	T	T	T	T	T	
	32	-	0,3	0,5	0,6	1	-	-	-	-	0,48	0,6	0,756	-	-	-	-	T	T	T	T	
	40	-	-	0,4	0,6	0,8	-	-	-	-	-	0,6	0,756	-	-	-	-	T	T	T	T	
	50	-	-	-	0,5	0,8	-	-	-	-	-	-	0,756	-	-	-	-	-	4	5	10	10
	63	-	-	-	-	0,65	-	-	-	-	-	-	-	-	-	-	-	-	3	5	10	10
DX ³ 36 kA C curve	80	-	-	-	-	-	-	-	-	-	-	-	-	-	-	-	-	-	-	5	6	
	10	0,5	0,7	1	1,8	3	-	-	-	0,5	0,7	1	1,8	-	-	-	T	T	T	T	T	
	16	0,3	0,5	0,7	1,3	2	-	-	-	0,384	0,5	0,7	1,3	-	-	-	T	T	T	T	T	
	20	-	0,4	0,5	1	1,6	-	-	-	0,384	0,48	0,6	1	-	-	-	T	T	T	T	T	
	25	-	-	0,5	0,8	1,3	-	-	-	0,384	0,48	0,6	0,8	-	-	-	-	T	T	T	T	
	32	-	-	0,5	0,8	1,3	-	-	-	0,384	0,48	0,6	0,8	-	-	-	-	T	T	T	T	
	40	-	-	0,4	0,6	0,8	-	-	-	-	0,48	0,6	0,756	-	-	-	-	T	T	T	T	
	50	-	-	-	0,5	0,8	-	-	-	-	-	-	0,756	-	-	-	-	-	4	5	10	10
	63	-	-	-	-	0,65	-	-	-	-	-	-	-	-	-	-	-	-	3	5	10	10
	80	-	-	-	-	-	-	-	-	-	-	-	-	-	-	-	-	-	-	-	5	6
DX ³ 50 kA B and C curves	100	-	-	-	-	-	-	-	-	-	-	-	-	-	-	-	-	-	-	5	6	
	125	-	-	-	-	-	-	-	-	-	-	-	-	-	-	-	-	-	-	-	3	
	≤ 6	0,7	1,2	1,5	3	4	-	-	-	0,7	1,2	1,5	3	-	-	-	T	T	T	T	T	
	10	0,5	0,7	1	1,8	3	-	-	-	0,5	0,7	1	1,8	-	-	-	T	T	T	T	T	
	16	0,3	0,5	0,7	1,3	2	-	-	-	0,384	0,5	0,7	1,3	-	-	-	T	T	T	T	T	
	20	0,3	0,4	0,5	1	1,6	-	-	-	0,384	0,48	0,6	1	-	-	-	T	T	T	T	T	
	25	0,24	0,4	0,5	0,8	1,3	-	-	-	0,384	0,48	0,6	0,8	-	-	-	-	T	T	T	T	
	32	-	0,3	0,5	0,6	1	-	-	-	-	0,48	0,6	0,756	-	-	-	-	T	T	T	T	
	40	-	-	0,4	0,6	0,8	-	-	-	-	-	0,6	0,756	-	-	-	-	T	T	T	T	
	50	-	-	-	0,5	0,8	-	-	-	-	-	-	0,756	-	-	-	-	-	4	5	10	10
DX ³ 50 kA D curve	63	-	-	-	-	0,65	0,9	1,2	-	-	-	-	-	-	-	-	-	-	-	5	6	
	80	-	-	-	-	-	0,6	0,75	-	-	-	-	-	-	-	-	-	-	-	-	5	6
	100	-	-	-	-	-	-	0,75	-	-	-	-	-	-	-	-	-	-	-	-	5	6
	125	-	-	-																		

Protection of DC circuits

Protection of DC circuits

DX³ 6000 and DX³ 10000 MCBs (1P/2P/3P/4P - $I_n \leq 63$ A) designed for use in 230/400 V \sim supplies, can also be used in DC circuits. In this case, the following deratings and precautions must be taken into account:

1 - Protection against short-circuits

Max. magnetic tripping threshold: multiplied by 1.4
 Example: For a C curve MCB for which the AC tripping threshold is between 5 and 10 I_n , the DC tripping threshold will be between 7 and 14 I_n .

2 - Protection against overloads

The time/current thermal tripping curve is the same as for AC.

3 - Operating voltage

Max. operating voltage: 80 V per pole (60 V for single-pole + N MCBs). For voltages higher than this value, several poles must be wired in series.

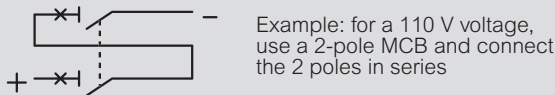

4 - Breaking capacity

4000 A for a single pole MCB at max. voltage (80 V \sim per pole).

For other voltages, the breaking capacities are as follows:

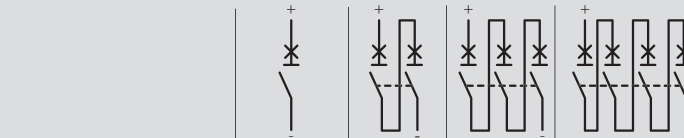

DX ³ 6000	voltage	single-pole	2P	3P	4P
Acc. to IEC 60947.2 Icu	≤ 48 V	6 kA	6 kA		
	110 V		6 kA	6 kA	
Ics ⁽¹⁾	230 V				10 kA
	≤ 48 V	100 %	100 %		
	110 V		100 %	100 %	
	230 V				100 %

DX ³ 10000	voltage	single-pole	2P	3P	4P
Acc. to IEC 60947.2 Icu	≤ 48 V	10 kA	10 kA		
	110 V		10 kA	10 kA	
Ics ⁽¹⁾	230 V				16 kA
	≤ 48 V	100 %	100 %		
	110 V		100 %	100 %	
	230 V				100 %

1: As a % of Icu

5 - Distribution of breaking poles

To choose the MCB and determine the pole distribution necessary for breaking on each of the polarities, it is necessary to know how the installation is earthed.

• Supply with one polarity earthed:

Place all the poles necessary for breaking on the other polarity. If isolation is required, an additional pole must be added on the earthed polarity.

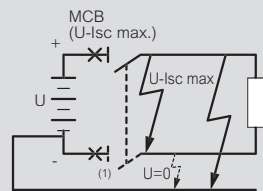

1: Only if isolation required

Example: circuit earthed via the negative polarity / $U = 110$ V \sim / $I_{sc} = 10$ kA / $I_n = 32$ A

Protect the positive polarity using an MCB capable of breaking 10 kA at 110 V (DX³ 10000 2P 32 A with 2 poles on the positive polarity). For isolation, use a DX³ 10000 3P 32 A with 2 poles on the positive polarity and one pole on the negative polarity.

DX ³ 10000	voltage	single-pole	2P	3P	4P
Acc. to IEC 60947.2 Icu	≤ 48 V	10 kA	10 kA		
	110 V		10 kA	10 kA	
	230 V				15 kA

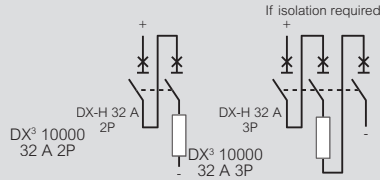

• Network earthed via a middle point:

Place on each polarity the number of poles necessary for max. I_{sc} breaking at half voltage.

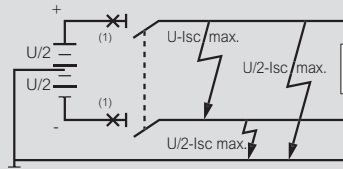

1: MCB ($U/2$ - I_{sc} max.)

Example: circuit earthed via a middle point / $U = 230$ V \sim / $I_{sc} = 6$ kA / $I_n = 10$ A

Protect each polarity using an MCB capable of breaking 6 kA at half voltage, i.e. 115 V (DX³ 6000 4P 10 A with 2 poles on each polarity).

DX ³ 6000	voltage	single-pole	2P	3P	4P
Acc. to IEC 60947.2 Icu	≤ 48 V	6 kA	6 kA		
	110 V		6 kA	6 kA	
	230 V				10 kA

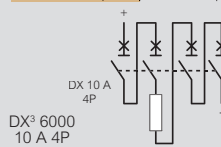

• Isolated earth supply:

Distribute the poles necessary for breaking over the 2 polarities to provide protection in the event of a double earth fault (particularly if there are a number of circuits in parallel).

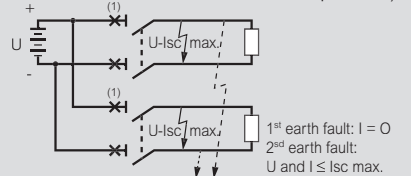

1: MCB (U - I_{sc} max.)

Example: isolated earth circuit / $U = 48$ V \sim / $I_{sc} = 4.5$ kA / $I_n = 40$ A. Protect the installation with an MCB capable of breaking 4.5 kA at 48 V and protect each polarity (DX³ 6000 MCB 2P 40 A with one pole on each polarity).

DX ³ 6000	voltage	single-pole	2P	3P	4P
Acc. to IEC 60947.2 Icu	≤ 48 V	6 kA	6 kA		
	110 V		6 kA	6 kA	
	230 V				10 kA

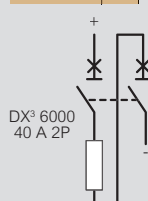

Pulse operated latching relays CX³



Dimensions **see e-catalogue**

Pack	Cat.Nos	Noiseless pulse operated latching relay	Pack	Cat.Nos	Signalling auxiliary																																													
1	4 124 00	<p>Conform to standard EN 60669-2-2</p> <p>Single pole - 16 A - 250 V\sim</p> <table border="1"> <tr> <td>Control voltage</td> <td>Type of contact</td> <td>Connection</td> <td>Number of modules</td> </tr> <tr> <td>230 V</td> <td>1 N/O</td> <td></td> <td>1</td> </tr> </table>	Control voltage	Type of contact	Connection	Number of modules	230 V	1 N/O		1	1	4 124 29	<p>Fitted on left-hand side of latching relay (equipped or not with control auxiliary)</p> <p>Maximum 2 auxiliaries per latching relay</p> <p>Used to signal the status of the contacts on the associated product</p> <p>Auxiliary changeover switch</p> <table border="1"> <tr> <td>I max.</td> <td>Voltage</td> <td>Contact</td> <td>Number of modules</td> </tr> <tr> <td>5 A</td> <td>250 V\sim</td> <td>N/C + N/O</td> <td>0.5</td> </tr> </table>	I max.	Voltage	Contact	Number of modules	5 A	250 V \sim	N/C + N/O	0.5																													
Control voltage	Type of contact	Connection	Number of modules																																															
230 V	1 N/O		1																																															
I max.	Voltage	Contact	Number of modules																																															
5 A	250 V \sim	N/C + N/O	0.5																																															
1	4 124 01	<p>Delayed noiseless pulse operated latching relay</p> <p>Switch-off, pre-warning function</p> <p>Conform to standard EN 60669-2-2</p> <p>Single pole - 16 A - 250 V\sim</p> <table border="1"> <tr> <td>Control voltage</td> <td>Type of contact</td> <td>Connection</td> <td>Number of modules</td> </tr> <tr> <td>230 V</td> <td>1 N/O</td> <td></td> <td>1</td> </tr> </table>	Control voltage	Type of contact	Connection	Number of modules	230 V	1 N/O		1	1	4 124 33	<p>Control auxiliary</p> <p>Fitted on left-hand side of latching relay</p> <p>Maximum 1 control auxiliary per latching relay</p> <p>Compatible with signalling auxiliary Cat.No 4 124 29</p> <p>Auxiliary device for centralized control</p> <p>For a centralized control of different latching relays from one single point</p> <table border="1"> <tr> <td></td> <td></td> <td>Number of modules</td> </tr> <tr> <td>1</td> <td>4 124 33</td> <td>0.5</td> </tr> <tr> <td>1</td> <td>4 124 34</td> <td>0.5</td> </tr> </table>			Number of modules	1	4 124 33	0.5	1	4 124 34	0.5																												
Control voltage	Type of contact	Connection	Number of modules																																															
230 V	1 N/O		1																																															
		Number of modules																																																
1	4 124 33	0.5																																																
1	4 124 34	0.5																																																
1	4 124 04	<p>Standard pulse operated latching relays</p> <p>Conform to standard EN 60669-2-2</p> <p>Maximum 2 auxiliary devices per latching relay</p> <p>Single pole - 16 A - 250 V\sim</p> <table border="1"> <tr> <td>Control voltage</td> <td>Type of contact</td> <td>Connection</td> <td>Number of modules</td> </tr> <tr> <td>12 V</td> <td>1 N/O</td> <td rowspan="3"></td> <td>1</td> </tr> <tr> <td>24 V</td> <td>1 N/O</td> <td>1</td> </tr> <tr> <td>230 V</td> <td>1 N/O</td> <td>1</td> </tr> </table> <p>2-pole - 16 A - 250 V\sim</p> <table border="1"> <tr> <td>Control voltage</td> <td>Type of contact</td> <td>Connection</td> <td>Number of modules</td> </tr> <tr> <td>24 V</td> <td>2 N/O</td> <td rowspan="3"></td> <td>1</td> </tr> <tr> <td>48 V</td> <td>2 N/O</td> <td>1</td> </tr> <tr> <td>230 V</td> <td>2 N/O</td> <td>1</td> </tr> </table> <p>4-pole - 16 A - 250 V\sim</p> <p>Can be used for 3-pole assembly</p> <table border="1"> <tr> <td>Control voltage</td> <td>Type of contact</td> <td>Connection</td> <td>Number of modules</td> </tr> <tr> <td>24 V</td> <td>4 N/O</td> <td rowspan="2"></td> <td>2</td> </tr> <tr> <td>230 V</td> <td>4 N/O</td> <td>2</td> </tr> </table>	Control voltage	Type of contact	Connection	Number of modules	12 V	1 N/O		1	24 V	1 N/O	1	230 V	1 N/O	1	Control voltage	Type of contact	Connection	Number of modules	24 V	2 N/O		1	48 V	2 N/O	1	230 V	2 N/O	1	Control voltage	Type of contact	Connection	Number of modules	24 V	4 N/O		2	230 V	4 N/O	2	1	4 124 36	<p>Auxiliary device for general centralized control</p> <p>For simultaneous control of different groups of latching relays, already fitted with auxiliary device for centralised control 230 V\sim</p> <p>Cat.No 4 124 34</p> <table border="1"> <tr> <td></td> <td></td> <td>Number of modules</td> </tr> <tr> <td>1</td> <td>4 124 36</td> <td>1</td> </tr> </table>			Number of modules	1	4 124 36	1
Control voltage	Type of contact		Connection	Number of modules																																														
12 V	1 N/O			1																																														
24 V	1 N/O	1																																																
230 V	1 N/O	1																																																
Control voltage	Type of contact	Connection	Number of modules																																															
24 V	2 N/O		1																																															
48 V	2 N/O		1																																															
230 V	2 N/O		1																																															
Control voltage	Type of contact	Connection	Number of modules																																															
24 V	4 N/O		2																																															
230 V	4 N/O		2																																															
		Number of modules																																																
1	4 124 36	1																																																
1	4 124 10	<p>Surface mounting pulse operated latching relays</p> <p>10 A - 230 V\sim - 50/60 Hz</p> <p>Suitable for new installations or retrofitting of existing ones</p> <p>Compatible with electronic ballasts and fluocompact lamps</p> <p>Mounting on plate or in flush-mounting boxes</p> <p>Ø 67 mm</p> <p>Equipped with automatic terminals for flexible or rigid wires (max. 2.5 mm)</p> <p>Power : min. 7 W / max. 2300 W</p> <p>IP 20 - IK 04</p> <p>Dimensions: 49 x 46 x 26 mm</p> <p>Maximum current when used with illuminated push-buttons : 50 mA</p> <p>Noiseless</p>	1	4 124 37	<p>Auxiliary device for maintained contact</p> <p>Allows the control of a latching relay via one maintained contact (i.e. time switches)</p> <table border="1"> <tr> <td></td> <td></td> <td>Number of modules</td> </tr> <tr> <td>1</td> <td>4 124 37</td> <td>0.5</td> </tr> </table>			Number of modules	1	4 124 37	0.5																																							
			Number of modules																																															
1	4 124 37		0.5																																															
10	0 491 20	<p>Single pole</p>	1	4 124 39	<p>Compensator module</p> <p>Used to control 230 V\sim - 50 Hz pulse operated latching relays via illuminated push-buttons without malfunctions</p> <p>Connects to the terminals of the pulse operated latching relay coil</p> <p>Compensation:</p> <ul style="list-style-type: none"> - 1 compensator module for a total consumption of 3 to 6 mA (example: 6 to 11 illuminated push-buttons consuming 0.55 mA each) - 2 compensators modules for a total consumption of 6 to 9 mA (example: 12 to 17 illuminated push-buttons with consuming 0.5 mA each) <table border="1"> <tr> <td></td> <td></td> <td>Number of modules</td> </tr> <tr> <td>1</td> <td>4 124 39</td> <td>1</td> </tr> </table>			Number of modules	1	4 124 39	1																																							
			Number of modules																																															
1	4 124 39	1																																																
10	0 491 21	<p>Single pole with timer</p> <p>Enables energy savings by switching off lighting after a specified period</p> <p>Time delay adjustment from 1 to 60 min.</p> <p>Switch-off pre-warning function (can be disabled)</p>																																																

Pulse operated latching relays

Wiring diagrams

Signalling with auxiliary Cat.No 4 124 29

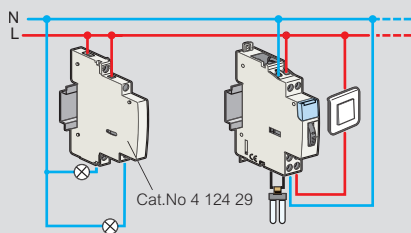

Centralized control at one point using auxiliary devices Cat.Nos 4 124 34 and 4 124 36

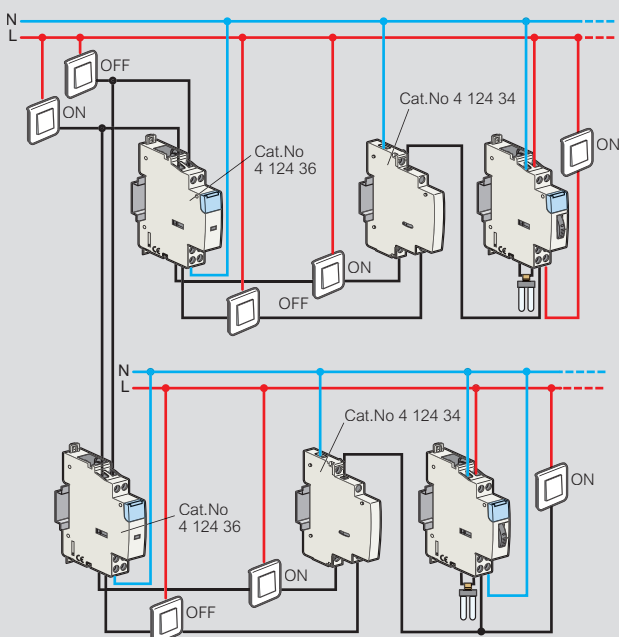

Use only non illuminated push-buttons

Control via maintained contact using auxiliary device Cat.No 4 124 37 and time switch

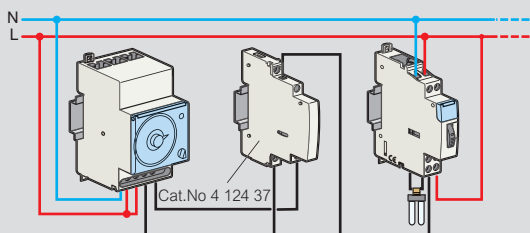

Technical characteristics

Power consumption

Cat.Nos	4 124 00 4 124 01	4 124 04	4 124 05 4 124 10	4 124 14	4 124 11	4 124 08 4 124 12	4 124 16
Control voltage	230 V~	12 V~	24 V~	24 V~	48 V~	230 V~	230 V~
Nominal current	16 A	16 A	16 A	16 A	16 A	16 A	16 A
Connection	1 N/O	1 N/O	1 N/O 2 N/O	4 N/O	2 N/O	1 N/O 2 N/O	4 N/O
Number of modules	1	1	1	1	1	1	2
Holding	-	670 mA	280 mA	570 mA	170 mA	30 mA	50 mA
Inrush	-	2500 mA	1200 mA	2500 mA	700 mA	130 mA	250 mA

Connection cross section mm²

Type of conductors	Cross section
Rigid	1 x 6 mm ² or 2 x 2.5 mm ²
Flexible	1 x 6 mm ² or 2 x 2.5 mm ²
Flexible with single ferrule	6 mm ²
Flexible with double ferrule	2 x 4 mm ²

Power contactors with handle CX³

from 25 A to 63 A

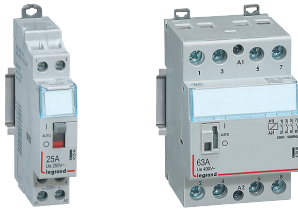

4 125 44

4 125 56

Dimensions **see e-catalogue**
 Technical characteristics **p. 57**

Conform to IEC/EN 61095
 Space for power supply busbar on top (up to 25 A)

Pack	Cat.Nos	Power contactors with 24 V~ coil and handle			
		Manual override for test and repair function, carried out via the handle Permanent "ON" or "OFF" without automatic reset			
		2-pole - 250 V~			
1	4 125 14	I max 25 A		Type of contact 2 N/O	Number of modules 1
1	4 125 15 ¹	40 A		2 N/O	2
1	4 125 16 ¹	63 A		2 N/O	2
		4-pole - 400 V~			
1	4 125 17	25 A		4 N/O	2
1	4 125 18 ¹	40 A		4 N/O	3
1	4 125 19 ¹	63 A		4 N/O	3
		Low noise power contactors with 230 V~ coil and handle			
		2-pole - 250 V~			
1	4 125 58	I max 25 A		Type of contact 2 N/O	Number of modules 1
1	4 125 59 ¹	40 A		2 N/O	2
1	4 125 60 ¹	63 A		2 N/O	2
		4-pole - 400 V~			
1	4 125 61	25 A		4 N/O	1
1	4 125 62 ¹	40 A		4 N/O	2
1	4 125 63 ¹	63 A		4 N/O	2

Pack	Cat.Nos	Power contactors with 230 V~ coil and handle			
		Manual override for test and repair function, carried out via the handle Permanent "ON" or "OFF" without automatic closing of the contactor			
		2-pole - 250 V~			
4	4 125 44	I max 25 A		Type of contact 2 N/O	Number of modules 1
1	4 125 45 ¹	40 A		2 N/O	2
1	4 125 47 ¹	63 A		2 N/O	2
1	4 125 48 ¹	63 A		2 N/C	2
		3-pole - 400 V~			
1	4 125 49 ¹	40 A		3 N/O	3
1	4 125 50 ¹	63 A		3 N/O	3
		4-pole - 400 V~			
2	4 125 51	25 A		4 N/O	2
1	4 125 53 ¹	40 A		4 N/O	3
1	4 125 56 ¹	63 A		4 N/O	3
1	4 125 57 ¹	63 A		4 N/C	3

1: Handle can be accessed after removing blanking plate

Power contactors without handle CX³

from 16 A to 63 A



Dimensions **see e-catalogue**
 Technical characteristics **see opposite**

Conform to IEC/EN 61095
 Space for power supply busbar on top (up to 25 A)

Pack	Cat.Nos	Power contactors with 24 V~ coil		
		2-pole - 250 V~		
1	4 125 03	I max 16 A	Connection 	Type of contact N/C + N/O Number of modules 1
1	4 125 05	25 A		2 N/O 1
		4-pole - 400 V~		
1	4 125 10	25 A		4 N/O 2
1	4 125 09	25 A		2 N/C + 2 N/O 2

Pack	Cat.Nos	Power contactors with 230 V~ coil		
		2-pole - 250 V~		
4	4 125 21	I max 16 A	Connection 	Type of contact N/C + N/O Number of modules 1
10	4 125 23	25 A		2 N/O 1
1	4 125 27	63 A		2 N/O 2
1	4 125 24	25 A		2 N/C 1
		4-pole - 400 V~		
5	4 125 35	25 A		4 N/O 2
1	4 125 41	63 A		4 N/O 3
1	4 125 36	25 A		4 N/C 2
1	4 125 33	25 A		2 N/C + 2 N/O 2

Pack	Cat.Nos	Signalling auxiliaries for contactors			
		Auxiliary changeover switch for all CX ³ contactors Used to signal the position status of the contacts on the product to which it is connected			
		For 1 module contactors 16 A to 25 A Maximum 2 auxiliary devices per contactor Fitted on left-hand side of contactor			
1	4 124 29	I max 5 A	Voltage 250 V~	Contact N/C + N/O	Number of modules 0.5
		For 2 module contactors 25 A Maximum 2 auxiliary devices per contactor Fitted on left-hand side of contactor			
1	4 124 30	5 A	250 V~	N/C + N/O	0.5
		For 40 and 63 A contactors Maximum 1 auxiliary device per contactor Fitted on left-hand side of contactor			
1	4 124 31	5 A	250 V~	N/C + N/O	0.5

For detailed dimensions,
see e-catalogue



Power contactors CX³

Technical characteristics

- Rated impulse withstand voltage (Uimp): 4 kV
- Mechanical endurance (no. of operating cycles): 10⁶ cycles
- Operating temperatures: - 25 °C to + 40 °C
- Storage temperatures: - 40 °C to + 70 °C

Contactor protection against short circuits according to standard EN 61095, conditional short-circuit current:

- I_q = 6 kA for 16 to 25 A contactors
- I_q = 3 kA for 40 to 63 A contactors

Circuit breaker or gG fuse rated:

- ≤ 16 A for 16 A rating • ≤ 40 A for 40 A rating
- ≤ 25 A for 25 A rating • ≤ 63 A for 63 A rating

Consumption of a contactor control coil

16 A and 25 A power contactors					
Coil voltage	24 V~		230 V~ low noise	230 V~	
	Current	16 A and 25 A	25 A	25 A	16 A and 25 A
Type of contact	NC + NO 2 NO	4 NO	2 NO	NC + NO 2 NO 2 NC	2 NC + 2 NO 4 NO 4 NC
Dimensions	1 mod.	2 mod.	1 mod.	1 mod.	2 mod.
Holding current	200 mA	300 mA	12 mA	20 mA	20 mA
Inrush current	970 mA	2500 mA	60 mA	90 mA	200 mA

40 A and 63 A power contactors				
Coil voltage	24 V~		230 V~	
	Current	40 A and 63 A	40 A and 63 A	40 A and 63 A
Type of contact	2 NO	4 NO	2 NO 2 NC	3 NO 4 NO 4 NC
Dimensions	2 mod.	3 mod.	2 mod.	3 mod.
Holding current	250 mA	270 mA	15 mA	30 mA
Inrush current	1750 mA	1500 mA	150 mA	200 mA

Recommendations

- Insert a spacing module (Cat.No 4 063 07 p. 45):
- every two contactors when the ambient temperature is below 40 °C
- every contactor when the ambient temperature is between 40 and 60 °C

Contactor rating	40 °C	50 °C	60 °C
I _e = 16 A	16 A	14 A	12 A
I _e = 25 A	25 A	22 A	20 A
I _e = 40 A	40 A	36 A	32 A
I _e = 63 A	63 A	57 A	50 A

Max. connection cross-section in mm²

Conductor type	Ratings ≤ 25 A	Ratings 40 & 63 A
Rigid	6 ² or 2 x 2.5 ²	25 ² or 2 x 10 ²
Flexible	6 ² or 2 x 2.5 ²	25 ² or 2 x 10 ²
Flexible with single end cap	6 ²	16 ²
Flexible with double end cap	2 x 4 ²	2 x 16 ²

Contactor selection charts

Incandescent lamps

Tungsten and halogen filaments 230 V~								
Nominal wattage	40 W	60 W	75 W	100 W	150 W	200 W	500 W	1000 W
16 A	45	30	24	19	13	10	4	2
25 A	60	48	38	30	20	15	6	3
40 A	96	77	61	48	32	24	10	5
63 A	154	123	97	77	51	38	15	8

Nominal wattage	ELV halogen bulbs with ferromagnetic ballast						ELV halogen bulbs with electronic ballast					
	20 W	35 W	50 W	75 W	100 W	150 W	20 W	35 W	50 W	75 W	100 W	150 W
16 A	32	20	15	12	9	6	60	40	28	18	14	9
25 A	52	30	24	16	12	8	80	50	40	26	20	13
40 A	68	39	31	21	16	10	112	70	56	36	28	18
63 A	88	51	41	27	20	14	157	98	78	51	39	25

Contactor selection charts (continued)

Fluorescent tubes with ferromagnetic ballast

Nominal wattage	Single parallel compensated fluorescent					Double series compensated fluorescent				
	18 W	20 W	36 W	58 W	115 W	2 x 20 W	2 x 36 W	2 x 40 W	2 x 58 W	2 x 140 W
16 A	24	24	16	11	5	30	24	22	15	6
25 A	33	30	25	17	9	45	38	35	24	10
40 A	43	39	33	22	12	68	57	53	36	15
63 A	56	51	42	29	15	101	86	79	54	23

Nominal wattage	Quadruple series compensated fluorescent		Compact fluorescent with built-in starter			
	4 x 18 W		7 W	10 W	18 W	26 W
16 A	16		50	40	28	19
25 A	24		60	50	42	28
40 A	36		78	65	55	36
63 A	54		101	85	71	47

Fluorescent tubes with electronic ballast

Nominal wattage	Single fluorescent				Double fluorescent		
	18 W	30 W	36 W	58 W	2 x 18 W	2 x 36 W	2 x 58 W
16 A	72	42	36	22	36	20	12
25 A	110	68	58	36	56	30	19
40 A	165	102	87	54	84	45	29
63 A	248	153	131	81	126	68	43

Nominal wattage	Triple fluorescent (series compensated)		Quadruple fluorescent (series compensated)	
	3 x 14 W	3 x 18 W	4 x 14 W	4 x 18 W
16 A	34	26	26	20
25 A	46	38	37	28
40 A	62	51	52	39
63 A	84	69	73	55

Nominal wattage	Compact fluorescent with built-in electronic power supply				
	7 W	11 W	15 W	20 W	23 W
16 A	120	80	64	50	43
25 A	200	125	90	70	60
40 A	280	175	126	98	84
63 A	392	245	176	137	118

Discharge lamps with compensation

Nominal wattage	Metal halogenide						Low pressure sodium vapour					
	35 W	70 W	100 W	150 W	250 W	400 W	18 W	35 W	55 W	90 W	135 W	180 W
16 A	10	6	5	3	2	1	12	6	5	3	2	2
25 A	15	9	7	5	3	2	20	10	7	5	3	3
40 A	23	14	11	8	5	3	30	15	11	8	5	5
63 A	34	20	16	11	7	5	45	23	16	11	7	7

Nominal wattage	High pressure sodium vapour					High pressure mercury vapour				
	70 W	150 W	250 W	400 W	1000 W	50 W	80 W	125 W	250 W	400 W
16 A	8	7	5	3	1	11	8	6	3	2
25 A	10	9	6	4	2	15	10	8	4	3
40 A	15	14	9	6	3	21	14	11	6	4
63 A	23	20	14	9	5	29	20	16	8	6

Nominal wattage	High pressure mixed			
	100 W	160 W	250 W	400 W
16 A	9	6	4	2
25 A	11	7	5	3
40 A	14	9	7	4
63 A	19	12	8	5

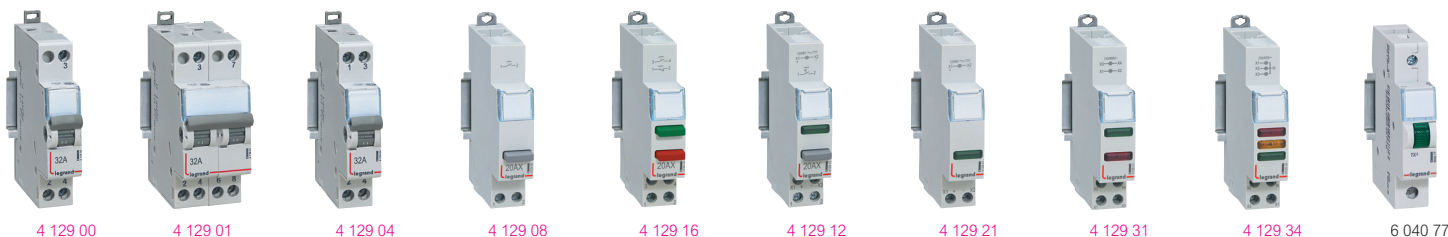

Technical characteristics [see e-catalogue](#)

Pack	Cat.Nos	Changeover switches	
		Conform to IEC 60669-1 Nominal rating 32 A Compatible with fluorescent lamps (20 AX)	
		Two-way - 250 V~	
10	4 129 00	Connection 	Number of modules 1
5	4 129 01	Double two-way - 400 V~ 	2
10	4 129 02	Two way with centre point - 250 V~ 	1
5	4 129 03	Double two way with centre point - 250 V~ 	2
10	4 129 04	Switch NO + NC - 250 V~ 	1

Pack	Cat.Nos	Push-buttons and control switches	
		Conform to IEC 60669-1 Nominal rating 20 A - 250 V~ Compatible with florescent lamps (20 AX) Accept prong-type supply busbars	
		Single function push-buttons	
10	4 129 08	1 NO Connection 	Number of modules 1
10	4 129 09	1 NC 	1
10	4 129 16	Dual functions push-buttons without indicator 1 NO (green push-button) + 1 NC (red push-button) 	1
10	4 129 10	Single function control switches 2 NO 	1
10	4 129 11	1 NO + NC 	1

Pack	Cat.Nos	Push-buttons and control switches (continued)		
		Dual functions control switches with indicator		
10	4 129 12	1 NO + green LED indicator 12/48 V~/=	Connection 	Number of modules 1
10	4 129 13	1 NC + red LED indicator 12/48 V~/=		1
10	4 129 14	1 NO + green LED indicator 110/400 V~		1
10	4 129 15	1 NC + red LED indicator 110/400 V~		1

Pack	Cat.Nos	LED indicators		
		Equipped with non replaceable LED lamps LED life: 100 000 h LED consumption: 0.17 W under 230 V~/ 0.11 W under 24 V~ Conform to IEC 60947-5-1 Accept prong-type supply busbars		
		Single - 12/48 V~/=		
10	4 129 21	● Green	Connection 	Number of modules 1
10	4 129 22	● Red		1
10	4 129 23	● Yellow		1
10	4 129 24	● Blue		1
10	4 129 25	○ White		1
10	4 129 26	● Green		1
10	4 129 27	● Red		1
10	4 129 28	● Yellow		1
10	4 129 29	● Blue		1
10	4 129 30	○ White		1
10	4 129 31	●● Green/Red		1
		Triple - 230/400 V~		
2 10	4 129 32	○ ○ ○ White		1
10	4 129 33	● ● ● Red		1
10	4 129 34	● ● ● Red/Yellow/Green		1
10	4 129 35	● ● ● Red/Yellow/Blue		1

Pack	Cat.Nos	LED indicators - 230 V~		
		Equipped with non replaceable LED lamps		
		Single		
12	6 040 77	● Green	Connection 	Number of modules 1
12	6 040 78	● Red		1
12	6 040 79	● Orange		1

CX³ changeover switches, push-buttons, control switches and LED indicators

technical characteristics

■ Dimensions

Changeover switches

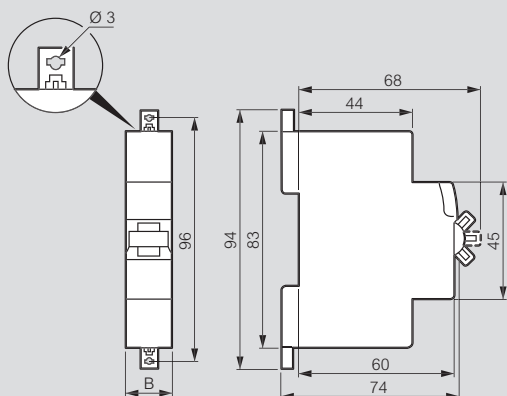

Cat.Nos	B
4 129 00/02/04	17.7
4 129 01/03	35.6

Push-buttons and control switches

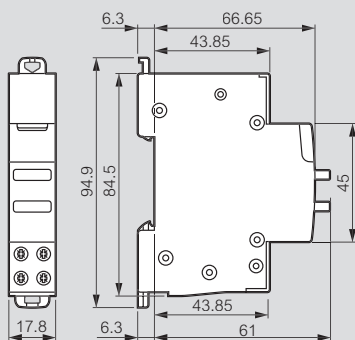

LED indicators

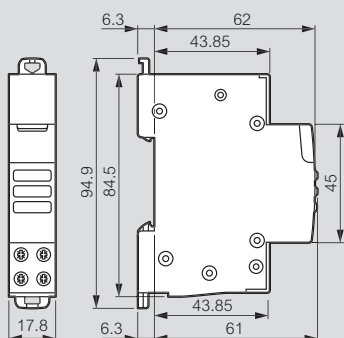

■ Technical characteristics

Changeover switches

Power dissipation per pole : 1.5 W
 Overvoltage category : 4 kV \sim
 Dielectric withstand : 2 kV \sim
 Degree of pollution : 2

Push-buttons and control switches

Electrical endurance : 30 000 cycles AC12
 ($\cos \phi = 0.9$) IEC 60947-5-1
 Electrical endurance under fluorescent loads : 30 000 cycles according to IEC 60669-1

LED indicators

Equipped with non replaceable LED lamps
 LED life : 100 000 h.
 LED consumption :
 - 0.17 W under 230 V \sim
 - 0.11 W under 24 V \sim

Programmable time switches

with digital display



Dimensions [see e-catalogue](#)

For switching an electric circuit (lighting, heating) ON or OFF at selected times during a pre-programmed time period
Temporary (automatic return) or permanent (forced switching ON or OFF) override on output

Pack	Cat.Nos	Standard - daily or weekly programme with 6 years clock working reserve	Pack	Cat.Nos	2 outputs multiple functions annual programme - 5 years clock working reserve
1	0 037 05	<p>Compatible with alternative renewable energy systems such as photovoltaic panels Automatic summer/winter changeover Clock precision: ± 1 sec per day Minimum programme setting: 1 min 28 programmes</p> <p>Power supply 120/230 V\sim - 50/60 Hz 1 output 16 A - 250 V\sim $\mu \cos \phi = 1$ per 1 inverter contact Low consumption: 0.1 W</p>	1	4 126 30	<p>Programme settings: on daily, weekly or yearly basis 15 languages A programme consists of a on and off time and their assignement to certain days Option to suspend the programme for a specific period to set-up with start and date Minimum programme setting: 1 s. High precision clock: ± 0.1 sec per day Programmed directly on keypad, or using program transfer key Cat.No 4 128 72</p> <p>Power supply 230 V\sim - 50/60 Hz 2 outputs - 230 V\sim - 50/60 Hz Astronomical function 2 x 3 x 28 = 168 programmes</p>
1	4 126 31	<p>Multiple functions - daily or weekly programme - 5 years clock working reserve Programme settings: on daily or weekly basis 15 languages A programme consists of a on and off time and their assignement to certain days Option to suspend the programme for a specific period to set-up with start and date Minimum programme setting: 1 s. High precision clock: ± 0.1 sec per day Particularly suited to irregular cycles: - security installations (access point, alarms, etc.), - industrial installations (pump stations, etc.) Programmed directly on keypad, or using program transfer key Cat.No 4 128 72 Additional functions including random (irregular cycles), hour counters</p>	1	0 047 70	<p>4 outputs multiple functions annual programme - 5 years clock working reserve 15 languages High precision clock: ± 0.2 sec per day For programming periods throughout the year 28 programmes per channel possible: - daily - weekly / astronomical programmes - yearly programmes - exceptional programmes Manual override (switch on and off) for every channel on the front of the switch Programmed directly on keypad, or using programme transfer key supplied</p>
1	4 126 41	<p>Power supply 230 V\sim - 50/60 Hz 1 output 16 A - 250 V\sim 56 programmes $\mu \cos \phi = 1$ per 1 inverter contact</p>	2	0 047 82	<p>Annual programme 4 outputs - 120/230 V\sim - 50/60 Hz Astronomical function</p>
1	4 126 54	<p>2 output 16 A - 250 V\sim 2 x 28 programmes $\mu \cos \phi = 1$ per 2 inverters contacts</p>	1	4 128 72	<p>Battery Working reserve 5 years for Cat.No 0 047 70</p>
1	4 126 57	<p>1 output 16 A - 250 V\sim Astronomical function 56 programmes $\mu \cos \phi = 1$ per 1 inverter contact</p>	1	4 128 73	<p>Programming transfer key Can be used to store programme settings made: - Directly on a multifunction and multi-programme time switch Cat.Nos 4 126 30/31/32/33/41/54/57 (loading on device) - with the programming software installed on a PC running Windows (loading on data loader)</p>
1	4 126 32	<p>2 outputs 16 A - 250 V\sim Astronomical function 2 x 28 programmes $\mu \cos \phi = 1$ per 2 inverter contacts</p>	1		<p>Programming software Can be used to create, save and transfer program settings for multifunction and multi-program time switches, Cat.Nos 0 047 70, 4 126 30/31/32/33/41/54/57 Data is transferred to the program transfer key Cat.No 4 128 72, using the data loader connected to the USB port of the PC Kit comprising software on CD-ROM, data loader and transfer key Windows XP, Windows 7, Windows 8 compatible</p>
1	4 126 33	<p>1 output 16 A - 120 V\sim 56 programmes $\mu \cos \phi = 1$ per 1 inverter contact</p> <p>Power supply 24 V\sim - 50/60 Hz and = 1 output 16 A - 24 V\sim 56 programmes $\mu \cos \phi = 1$ per 1 inverter contact</p>	2		

Programmable time switches

with analogue dial



Programmable time switches

with analogue and digital dial



4 127 90

4 127 95

Dimensions [see e-catalogue](#)

Programmed via captive segment
 Power supply: 230 V \sim - 50/60 Hz
 3-position override switch "ON-AUTO-OFF" on front panel
 Manual changeover to summer/winter time
 1 outlet 16 A - 250 V \sim - μ cos = 1

Pack	Cat.Nos	Daily programme	Number of modules
1	4 127 80	1 segment = 15 minutes Accuracy: \pm 5 minutes Vertical dial Minimum switching time: 15 minutes N/O contact Without working reserve	1
1	4 127 90	With 100 h working reserve	1
1	4 128 12	Horizontal dial Minimum switching time: 15 minutes Changeover switch Without working reserve	3
1	4 128 13	With 100 h working reserve	3
Weekly programme			
1	4 127 94	1 segment = 2 hours Accuracy: \pm 30 minutes Vertical dial Minimum switching time: 2 hours N/O contact With 100 h working reserve	1
1	4 127 95	Horizontal dial Minimum switching time: 4 hours Changeover switch With 100 h working reserve	3

Diagrams

Cat.Nos 4 127 80/90/94

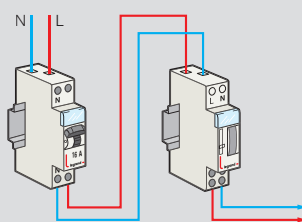

Cat.Nos 4 128 12/13, 4 127 95

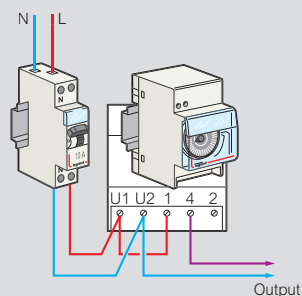

Cat.No 0 047 70

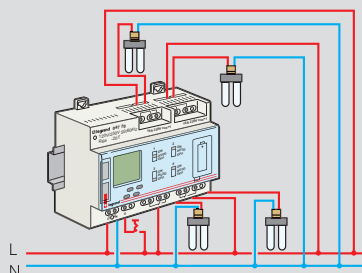

Cat.Nos 4 126 31/32/33

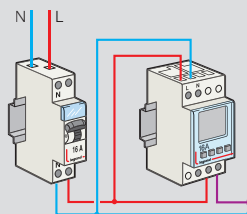

Cat.No 4 126 54

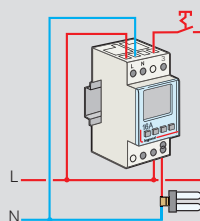

Cat.No 4 126 57

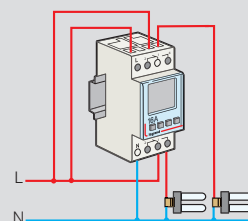

Output closing and breaking times are calculated based on the date, the actual time when the device was switched and on geographical coordinates of the actual location

Technical characteristics

Cat.Nos	Prog. time	Min. programme settings	Working reserve	Summer/winter time	Outputs 16 A	Nb of prog.	Nb of modules
0 037 05	7 d	1 min	5 years	auto	1	28	1
0 047 70	24 h/7 d/1 y	1 s	5 years	auto	4	4 x 3 x 28	6
4 126 30	1 year	1 s	5 years	auto	2	2 x 3 x 28	2
4 126 31	24 h/7 d	1 s	5 years	auto	1	56	2
4 126 32	24 h/7 d	1 s	5 years	auto	1	56	2
4 126 33	24 h/7 d	1 s	5 years	auto	1	56	2
4 126 41	24 h/7 d	1 s	5 years	auto	2	2 x 28	2
4 126 54	24 h/7 d	1 s	5 years	auto	1	56	2
4 126 57	24 h/7 d	1 s	5 years	auto	2	2 x 28	2

Cat.Nos	Programme	Segment	Min. switching time	Working reserve	16 A output via contact		Nb of modules
					N/O	Chang. S.	
4 128 12	24 h	15 min	30 min	without	-	1	3
4 128 13	24 h	15 min	30 min	100 h	-	1	3
4 127 80	24 h	15 min	15 min	without	1	-	1
4 127 90	24 h	15 min	15 min	100 h	1	-	1
4 127 94	7 d	2 h	2 h	100 h	1	-	1
4 127 95	7 d	2 h	4 h	100 h	-	1	3



Power supply 230 V \sim
 Override switching "ON" or "OFF" in front face
 1 output via changeover contact
 (2 changeover contacts for Cat.No 0 499 26)

Pack	Cat.Nos	Daily programme
1	6 499 14	20 A - 250 V\sim - μ cos φ = 1 Shortest switching time: 30 minutes (1 segment = 10 minutes) Switching accuracy: + 5 minutes
1	0 497 56	Weekly programme 16 A - 250 V\sim - μ cos φ = 1 Shortest switching time: 3 hours (1 segment = 1 hour) Switching accuracy: + 20 minutes Working reserve: 500 h with quartz controlled motor
1	0 044 09	Adaptor for fixing time switch on rail EN 50022
1	0 499 26	Defrosting time switch Time switch for short periods for control of defrosting, regularly repeated switching of pumps, feed conveyors, sprinkler systems, periodic lubrication of machines 16 A - 250 V \sim μ cos φ = 1 IP 30 Daily programme The timer can repeat one or two settable short programmes within 24 hours Shortest switching sequence 2.5 hours - up to 9 times 1 switching step = 1 segment = 30 min. 50 Hz Defrosting time from 1 to 60 minutes per contact
1	6 998 11	OmniRex - Plug-in time switches Manuel switch ON - Auto With 2P+ \neq plug and 10/16 A socket base and 16 A socket With child protection Override/manual switch Mains hold accuracy Synchronous motor, 230 V, 50 Hz 1 contact NO 250 V/50 Hz, 16 A \sim cos φ = 1
1	6 998 12	OmniRex T - 24-hour programme German standard - With child protection Switching step 15 min Mini switching time 15 min Switching accuracy \pm 5 min
1		OmniRex W - 7-day programme German standard - With child protection Switching step 2 hours Mini switching time 2 hours Switching accuracy \pm 30 min

Conform to EN 60730-1 and EN 60730-2-7

Digital daily weekly DIN rail mounting time switches
 A programme consists of a ON and OFF time and their assignment to certain days of the week (or a combination of days) and a selected channel (for the 2-channel version).

- Additional features:
- manual override (permanent ON or OFF)
 - automatic override (ON/OFF): actual program will be inversed (ON->OFF, OFF->ON) till next programmed ON time
 - working reserve : 3 years
 - replaceable battery

Pack	Cat.Nos	MicroRex D21 Plus
		1 channel 230 V\sim , 50/60 Hz Language
1	6 037 70	English
1	6 037 78	French
1	6 037 72	Spanish

Pack	Cat.Nos	MicroRex D22 Plus
		2 channels 230 V\sim , 50/60 Hz Language
1	6 037 71	English
1	6 037 79	French
1	6 037 73	Spanish

Electronic time-lag switches



Electronic time-lag switches



Dimensions **see e-catalogue**

Designed for supply busbar compatibility
 Power supply: 230 V~ - 50/60 Hz
 Switches a lighting circuit for a specific time
 Self-protection in the event of blocked pushbutton

Pack	Cat.Nos	Time-lag switch	Number of modules
10	4 126 02	Resettable 230 V~ - 50/60 Hz Timing adjustable from 0.5 sec to 10 min Manual override contact Output 16 A - 250 V~ - $\mu \cos \varphi = 1$ 2000 W incandescent/halogen 2000 W halogen - 230 V~ 1000 VA fluo - series compensated 120 VA fluo - parallel compensated 14 μF 100 VA compact fluorescent 1000 W energy saving lamp automatic 3-wire or 4-wire connection	1

Pack	Cat.Nos	Multi-function time-lag switch	Number of modules
10	0 047 04	Resettable 230 V~ - 50/60 Hz Timing adjustable from 0.5 sec to 12 min Operation with 3 or 4 wires automatically recognised by the time-lag switch - Inputs for separate control 8-230 V (presence detection, lighting control by door entry system etc.) - Switch-off pre-warning function, - Long duration function (1 hour) and manual switch-off Output 16 A - 250 V~ - $\mu \cos \varphi = 1$ 3680 W incandescent/halogen 2000 W halogen 230 VA 1000 VA fluo - parallel compensated $\leq 100 \mu\text{F}$ 2000 VA compact fluorescent 500 W halogen lamp + ferromagnetic transformer 2000 W halogen lamp + electronic transformer - Specially suited to energy saving lamps 1000 W	1

Pack	Cat.Nos	Automatic staircase time-lag switch for wall mounting 230 V - 50 Hz	Type
1	0 497 83	Switches a lighting circuit during a determined period Controlled by illuminated push-button 50 mA max 3 wire connection Output : 1 contact Contact rating 10 A - 250 V~ - $\cos \varphi = 1$ Type of delay adjustable Electronic 0.5 to 10 min.	Resettable

Multi-function time-lag switch

4-wire

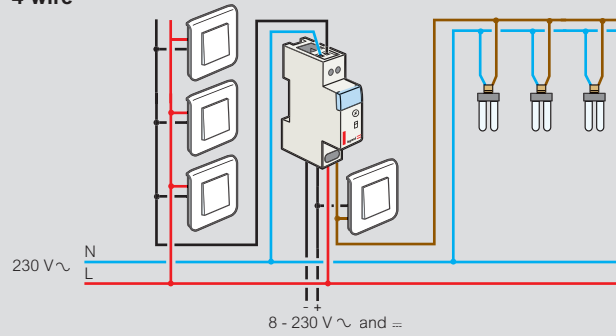

3-wire

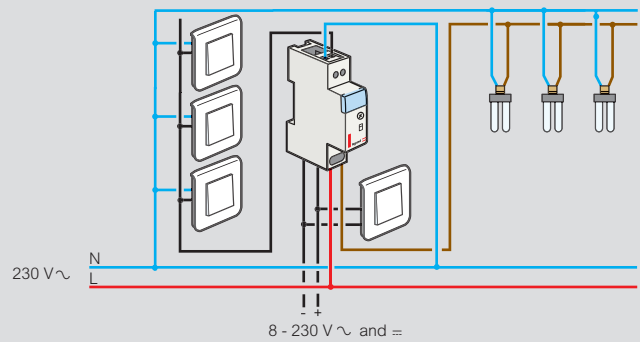

Multi-function time-lag switch: lighting control by door entry system

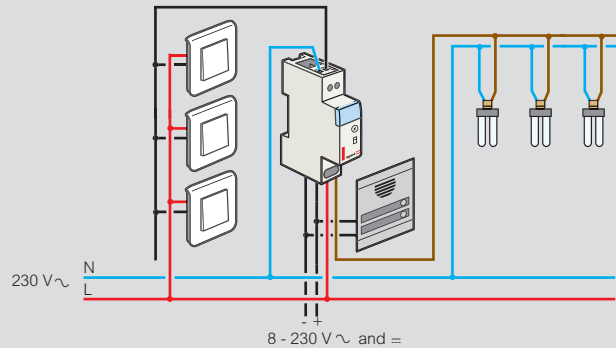

Switch-off pre-warning function

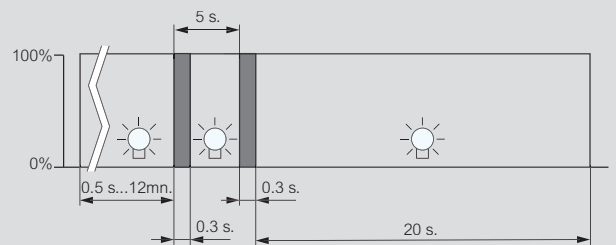

For fluorescent and energy saving lamps the switch-off period is longer than 0.3 s, because of re-starting time required by the lamps



4 126 23

4 126 26

4 128 58

Dimensions **see e-catalogue**

Can be used to switch a lighting circuit "ON" and "OFF" based on light conditions (nightfall, daybreak)
 Supplied with IP 65 weatherproof photoelectric cell
 Power supply: 230 V~ - 50/60 Hz

Pack	Cat.Nos	Standard
1	4 126 23	Output 16 A - 250 V~ - $\mu \cos \varphi = 1$ 2000 W incandescent 2000 W series compensated fluorescent 1000 W parallel compensated fluorescent 70 μ F 1000 W energy-saving bulb 2000 W halogen bulb + ferromagnetic transformer 2000 W halogen bulb + electronic transformer Automatic timer response Adjustable from 1 to 100 000 lux Number of modules: 1 Supplied with IP 65 photoelectric cell Cat.No 4 128 60
1	4 126 26	Programmable 56 programmes possible : daily, weekly or yearly programmes Output 16 A - 250 V~ - $\mu \cos \varphi = 1$ 2000 W incandescent 2000 VA series compensated fluorescent 1000 W energy-saving bulb Integrated hour counter High precision clock : ± 0.1 sec per day at 25°C Working reserve : 5 years Adjustable from 3 to 100 000 lux Automatic changeover between summer/winter time Number of modules: 2 Programmed directly on keypad, or using programme transfer key Cat.No 4 128 72 (p. 60) Supplied with IP 65 photoelectric cell Cat.No 4 128 60
1	4 128 60	Replacement IP 65 photoelectric cell IP 65 - IK 07 For use with standard or programmable light sensitive switches Cat.Nos 4 126 23/26

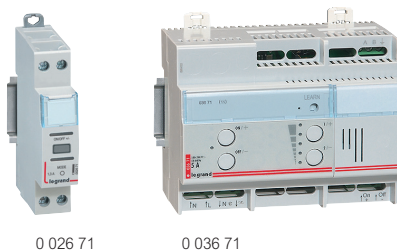

0 026 71

0 036 71

230 V~ - 50/60 Hz power supply

Pack	Cat.Nos	Remote control dimmers	Number of modules
1	0 036 58	Standalone operation Storage of the last lighting level in the event of a power cut or on a switch-off command For fluorescent lamps with 1-10 V electronic ballast Controllable power: 800 VA Control current: 50 mA max. Local and remote control Dimming via non-illuminated 1-gang pushbutton Compatible with energy-saving lamps (LEDs, CFLs) For loads: - 3 to 150 W LEDs/CFLs - 3 to 400 W for halogen lamps (built-in ballast) - 3 to 400 W for halogen lamps with electronic or ferromagnetic transformer Light level dimmed by holding down the button. Switch-off warning function 110-230 V, 50-60 Hz Max. standby consumption: 0.1 W DIN rail mounting Has space for inserting a supply busbar Can be installed instead of a remote control dimmer controlled via a pushbutton	2
1	0 026 71	Operation on a BUS Local and remote control via auxiliary controls or via pushbuttons, 1 or 2-gang, non-illuminated Supplied in 2-gang pushbutton version A 2-gang pushbutton (3 wires) can be changed to 1-gang (2 wires) by configuring the product Light indication of the load level via bargraph, which allows control to be viewed directly on the front panel. Can be combined with one another in master/slave mode by means of the BUS	2
1	0 036 60	For light sources with separate 1/10 V ballast (fluorescent tubes, compact fluorescent bulbs, LEDs, etc) Compatible with all loads which can be controlled by ballasts dimmable from 1 - 10 V Max. power: 1000 VA Control current: 50 mA max.	4
1	0 036 71	For incandescent, halogen, ELV halogen lamps with ferromagnetic or electronic transformers Automatic recognition of the load Self-regulating against overloads Max. power: 1000 W	6
1	0 036 80	Power supply for BUS line BUS power supply for remote controlled dimmers Cat.Nos 036 60/71 For maximum 8 peripherals	2

Remote control dimmers

Wiring

800 VA remote control dimmer for fluorescent lamps Cat. No. 0 036 58

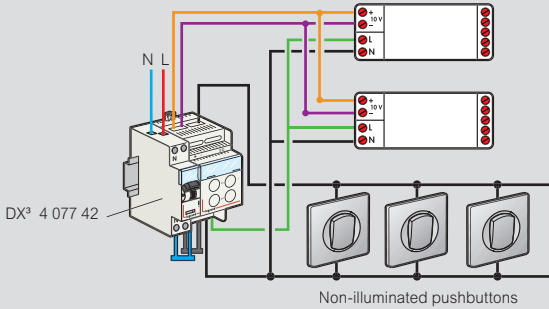

400 W remote control dimmer for energy-saving and halogen lamps Cat. No. 0 026 71

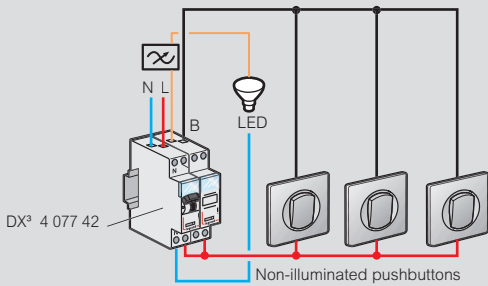

1000 VA remote control dimmer for incandescent, halogen, ELV halogen lamps with ferromagnetic or electronic transformers Cat. No. 0 036 71

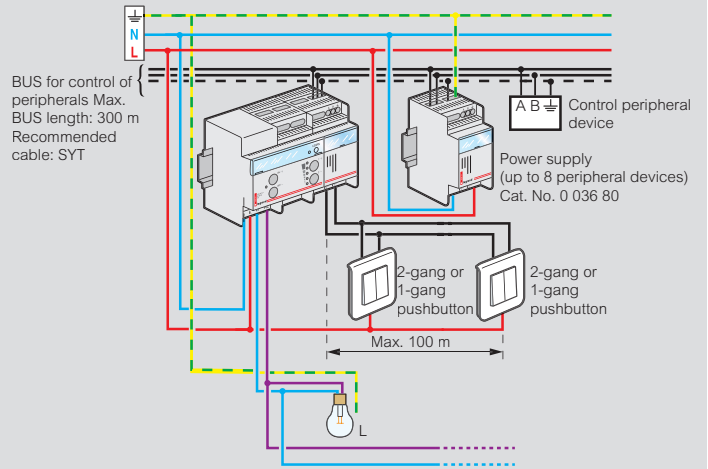

1000 VA remote control dimmer for light sources with 1-10 V ballast Cat. No. 0 036 60

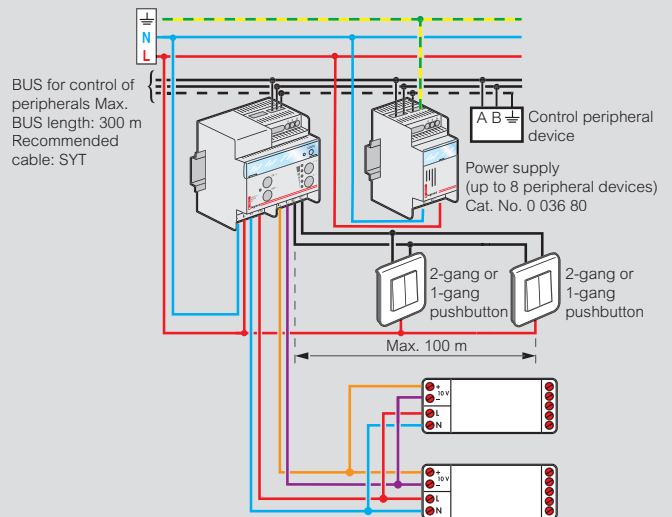

Select your dimmer

Cat.Nos	Power		1	2	3	4	5	6
	Max.	Min.						
0 036 58	Max.	800 VA						
	Min.	-	no	yes with 1-10 V ballast	no	yes with 1-10 V ballast	yes with 1-10 V ballast	yes with 1-10 V ballast
0 026 71	Max.	400 W	yes (min: 3 W max: 400 W)	no	yes (min: 3 VA max: 400 VA)	yes (min: 3 VA max: 400 VA)	no	yes (min: 3 W max: 150 W)
	Min.	3 W						
0 036 60	Max.	1000 VA						
	Min.	-	no	yes with 1-10 V ballast	no	yes with 1-10 V ballast	yes with 1-10 V ballast	yes with 1-10 V ballast
0 036 71	Max.	1000 VA						
	Min.	-	yes	no	yes	yes	no	no

- 1 230 V halogen lamps
- 2 Fluorescent lamps T5/T8
- 3 ELV halogen lamps with ferromagnetic transformer
- 4 ELV halogen lamps with electronic transformer
- 5 Compact fluorescent lamps with separate 1-10 V electronic ballast
- 6 LED

Time delay relays

12 to 230 VA and =

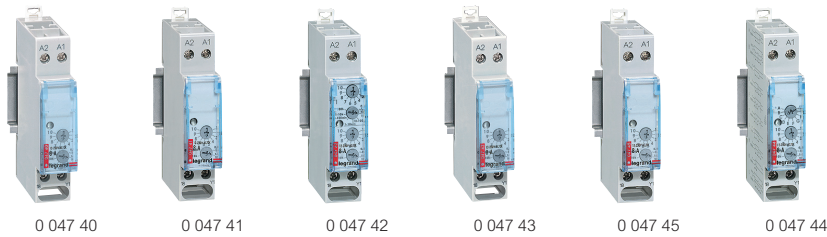

Dimensions [see e-catalogue](#)

For controlling the switching ON or OFF of a circuit (lighting, ventilation, automation, signalling) in operation for a specific time from 0.1 sec to 100 hrs
 Supply voltage: 12 to 230 V \sim (50/60 Hz) and =
 Output: 8 A - 250 V \sim - μ cos φ = 1 per inverter contact

Pack	Cat.Nos	Time delay relays	Number of modules	Pack	Cat.Nos	Time delay relays (continued)	Number of modules
1	0 047 40	ON delay Delays load switch-on (alarm, lighting, contactor) The time period starts when the relay is switched ON. At the end of the time period (T), the load is switched ON	1	1	0 047 43	Timer (pulse) For switching a load ON for a specific time (contactor) The time period (T) starts with the closing of the non-illuminated switch or pushbutton. At the end of the time period, the load is switched OFF	1
1	0 047 41	OFF delay Delays load switch-off (ventilation, etc.) The time period (T) starts with the opening of the non-illuminated switch or pushbutton. At the end of the time period, the load is switched OFF	1	1	0 047 45	Wipe contact flick contactor For switching a load ON for a specific time The time period (T) starts when the relay is switched ON. At the end of the time period (T), the load is switched OFF	1
1	0 047 42	Flashing For switching ON and OFF a load (lighting, sounder) for different times and cyclically 	1	1	0 047 44	Multifunction <ul style="list-style-type: none"> • ON delay • OFF delay • ON/OFF delay • Timer (pulse) • Timer and passing contact • Flashing • Totalizer on delay • Totalizer delay on power-up 	1

For detailed dimensions, [see e-catalogue](#)



Transformers, buzzers and bells

Socket outlets and special supports



4 130 91



4 130 98



0 041 07



0 042 80



0 042 85

Dimensions **see e-catalogue**

Pack	Cat.Nos	Bell transformers																								
		<p> Conform to IEC / EN 61558-2-8 Protected against overloads and short circuits. In the event of an overload, switch «OFF» the power supply and allow the transformer to cool down before switching on again With label holders Wall or rail mounting (for 4 modules) Possibility for supply busbars to run through (Cat.No 4 130 91)</p> <p>230 V/12 V - 8 V</p> <table border="1"> <thead> <tr> <th>Secondary (V)</th> <th>Rating (A)</th> <th>Power (VA)</th> <th>Number of modules</th> </tr> </thead> <tbody> <tr> <td>8</td> <td>0.5</td> <td>4</td> <td>2</td> </tr> <tr> <td>12/8</td> <td>0.66/1</td> <td>8</td> <td>2</td> </tr> <tr> <td>12/8</td> <td>2/3</td> <td>24</td> <td>4</td> </tr> </tbody> </table> <p>230 V/24 V - 12 V</p> <table border="1"> <thead> <tr> <th>Secondary (V)</th> <th>Rating (A)</th> <th>Power (VA)</th> <th>Number of modules</th> </tr> </thead> <tbody> <tr> <td>24/12</td> <td>1/1.5</td> <td>24 - 18</td> <td>4</td> </tr> </tbody> </table>	Secondary (V)	Rating (A)	Power (VA)	Number of modules	8	0.5	4	2	12/8	0.66/1	8	2	12/8	2/3	24	4	Secondary (V)	Rating (A)	Power (VA)	Number of modules	24/12	1/1.5	24 - 18	4
Secondary (V)	Rating (A)	Power (VA)	Number of modules																							
8	0.5	4	2																							
12/8	0.66/1	8	2																							
12/8	2/3	24	4																							
Secondary (V)	Rating (A)	Power (VA)	Number of modules																							
24/12	1/1.5	24 - 18	4																							
1	4 130 90																									
1	4 130 91																									
1	4 130 92																									
1	4 130 93																									

Pack	Cat.Nos	Safety transformers																						
		<p> Conform to IEC / EN 61558-2-6 Protected against overloads and short circuits. In the event of an overload, switch «OFF» the power supply and allow the transformer to cool down before switching on again Wall or rail mounting (for 4 modules)</p> <p>230 V/12 or 24 V (per coupling 2 x 12 V for Cat.No 4 130 98) Supplied with strip</p> <table border="1"> <thead> <tr> <th>P</th> <th>No-load loss (VA)</th> <th>No-load loss (W)</th> <th>Voltage drop % Cos φ = 1</th> <th>Efficiency % Cos φ = 1</th> <th>Ucc (%)</th> <th>I (A) primary loaded</th> <th>Number of modules</th> </tr> </thead> <tbody> <tr> <td>25</td> <td>2.5</td> <td>29</td> <td>66</td> <td>23.3</td> <td>0.142</td> <td>4</td> </tr> <tr> <td>63</td> <td>4</td> <td>15.7</td> <td>75</td> <td>13.6</td> <td>0.33</td> <td>5</td> </tr> </tbody> </table>	P	No-load loss (VA)	No-load loss (W)	Voltage drop % Cos φ = 1	Efficiency % Cos φ = 1	Ucc (%)	I (A) primary loaded	Number of modules	25	2.5	29	66	23.3	0.142	4	63	4	15.7	75	13.6	0.33	5
P	No-load loss (VA)	No-load loss (W)	Voltage drop % Cos φ = 1	Efficiency % Cos φ = 1	Ucc (%)	I (A) primary loaded	Number of modules																	
25	2.5	29	66	23.3	0.142	4																		
63	4	15.7	75	13.6	0.33	5																		
1	4 130 96																							
1	4 130 98																							

Pack	Cat.Nos	Buzzers and bells																									
		<p>Buzzers and bells 50 Hz AC - Connection by screw terminals, with label holder Allow insertion of supply busbars Caution: remove lamps from illuminated push-buttons when used with Cat.Nos 0 041 01</p> <p>Bells</p> <table border="1"> <thead> <tr> <th>Voltage (V~)</th> <th>Power (VA)</th> <th>Consum. (mA)</th> <th>Acoustic power¹(dB)</th> <th>Number of modules</th> </tr> </thead> <tbody> <tr> <td>8/12</td> <td>4/5</td> <td>360/420</td> <td>80/84</td> <td>1</td> </tr> <tr> <td>230</td> <td>6</td> <td>27</td> <td>83</td> <td>1</td> </tr> </tbody> </table> <p>Buzzers</p> <table border="1"> <thead> <tr> <th>Voltage (V~)</th> <th>Power (VA)</th> <th>Consum. (mA)</th> <th>Acoustic power¹(dB)</th> <th>Number of modules</th> </tr> </thead> <tbody> <tr> <td>230</td> <td>6</td> <td>27</td> <td>73</td> <td>1</td> </tr> </tbody> </table>	Voltage (V~)	Power (VA)	Consum. (mA)	Acoustic power ¹ (dB)	Number of modules	8/12	4/5	360/420	80/84	1	230	6	27	83	1	Voltage (V~)	Power (VA)	Consum. (mA)	Acoustic power ¹ (dB)	Number of modules	230	6	27	73	1
Voltage (V~)	Power (VA)	Consum. (mA)	Acoustic power ¹ (dB)	Number of modules																							
8/12	4/5	360/420	80/84	1																							
230	6	27	83	1																							
Voltage (V~)	Power (VA)	Consum. (mA)	Acoustic power ¹ (dB)	Number of modules																							
230	6	27	73	1																							
10	0 041 01																										
10	0 041 07																										
10	0 041 13																										

1: Acoustic power at 1 m

0 044 05
Equipment model:
auxiliary control0 044 06
Equipment model:
bulbs, switch0 802 99
Equipped with RJ45
socket

Dimensions **see e-catalogue**

Allow insertion of supply busbars

Pack	Cat.Nos	10-16 A - 250 V~	Number of modules
10	0 042 80	French standard 2P + \perp shuttered	2.5
10	0 042 85	German standard 2P + \perp shuttered	2.5
5	0 042 91	20 A - 400 V~ French standard 3P + \perp shuttered	3.5
5	0 042 92	3P + N + \perp shuttered	3.5
10	0 044 05	Special supports Pre-drilled support For mounting Ø22.5 mm control and signalling units	3
10	0 044 06	Support or blanking cover For other equipment (ex. switch, bulbs, printed-circuits...)	3
10	0 802 99	For mounting Mosaic 2-module mechanisms Support width 46.3 mm 2.5 modules	
10	4 063 07	Wiring management accessories Spacing unit with feedthrough 0.5 module Allows cables to run between two modular devices and creates an air channel in order to limit temperature rise	

Single phase power supplies



4 131 05



0 047 93

Dimensions [see e-catalogue](#)

For supplying PLCs and their peripherals or any use requiring a voltage of 5 V, 12 V, 15 V or 24 V_{DC}
Fixing on rail

Pack	Cat.Nos	Filtered rectified power supplies		
		Conform to standards IEC EN 61558-2-6 For equipment conforming to standards EN 61131-2, EN 60204 and EN 61439-1 Comprising: - A safety transformer with interference filtration - A filter capacitor - Protection by PTC integrated in the primary - Double operating terminals Terminal capacity: 6 mm ² flexible Class II after addition of faceplate Ripple factor < 3% Ambient temperature without derating: 60 °C Power supply 230 V ± 15 V _{AC}		
		12 V_{DC}		
		Power (W)	Current (A)	Number of modules
1	4 131 05	15	1.3	5
		15 V_{DC}		
1	4 131 06	15	1	5
		24 V_{DC}		
1	4 131 07	12	0.5	5
1	4 131 08	21.5	0.9	5

Pack	Cat.Nos	Stabilised power supplies		
		Conform to standards NF EN 61204, NF EN 60950 (Low Voltage Directive), EN 55022 (class B), EN 61000-4-2, EN 61000-3-26, ENV 50204 Switching mode Galvanic isolation 4000 V (input/output) With: - Electronic protection (overloads and short-circuits) - Integral fuse protection on input - A green voltage present indicator on output Power supply 115 - 230 V _{AC}		
		5 V_{DC}		
		Power (W)	Current (A)	Number of modules
1	0 047 91	12.5	2.5	6
		12 V_{DC}		
1	0 047 92	30	2.5	6
		24 V_{DC}		
1	0 047 93	24	1	4

Pack	Cat.Nos	Power supplies with battery back-up		
		Conform to standards IEC/EN 61558-2-6, EN 55022 (class B), EN 61000-4-2 With "ON"/"OFF" button, operation indicator, fuse protection Power supply 230 V _{AC}		
		12 V_{DC}		
		Capacity 280 mA/h		
		Power (W)	Current (A)	Number of modules
1	0 042 10	6	0.5	6

Single phase power supplies

Filtered rectified power supplies

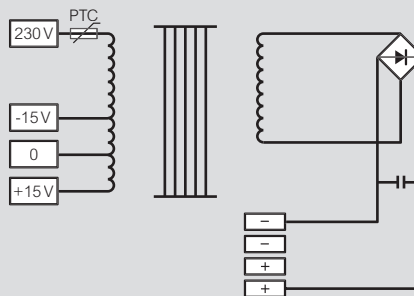

Cat.Nos	Voltage (V)	Current (A)	Weight (Kg)	I Prim. on load (A) at 230 V
4 131 05	12	1.3	0.95	0.15
4 131 06	15	1	0.95	0.15
4 131 07	24	0.5	0.95	0.13
4 131 08	24	0.9	0.95	0.17

Cat.Nos	Voltage of use				No load losses (W)	Total losses at 100% load (W)	Voltage drop cos φ = 1
	A no load (V)	On load (V)	With 100 kA load and prim. voltage + 10%	With nominal load and prim. voltage - 15%			
4 131 05	15.1	11.8	16.3	10.4	3.4	8.7	28.5
4 131 06	18.5	14.6	19.9	12.9	3.4	8.9	26.7
4 131 07	28.9	23.6	30.6	20.7	3.4	7.1	22.3
4 131 08	29.9	22.8	32.0	20.3	3.4	10.4	31.0

Stabilised power supplies

Cat.Nos	Secondary		Primary			Max. out current (A)	Power consumption at max. temp. (W)	Efficiency
	Voltage (V)	Current (A)	Voltage (V)	Current consump. max. (A)	Inrush current max. (A)			
0 047 91	5	2.5	109-264	0.15/0.35	16	2.5	12.5	58
0 047 92	12	2.5	109-264	0.3/0.55	11	2.5	30	
0 047 93	24	1	109-264	0.25/0.45	13	1	24	73

Cat.Nos	Starting time on energisation (s) 230 V/115 V	Hold time (at 230 V) (ms)	Operating temperature	Residual ripple peak to peak (mVpp)	Line protection		Dim.	Max. weight	Max. operating temperature with derating (°C)
					With fuse (A)	With MCB (A) + type			
0 047 91	2.4/0.8	90	-10/+50	35	1A aM	2A/C	6 modules	0.32	50
0 047 92	10/3.7	115	-10/+50	20	1A aM	2A/C	6 modules	0.32	50
0 047 93	2.6/1	124	-10/+50	80	2A aM	6A/C	4 modules	0.25	50

PTC protection

PTC: Positive temperature coefficient (limitation of overloads and temperature). In the event of an overload switch "off" the power supply and allow the power supplies to cool down before switching on again

EMDX³ electrical energy meters

┌ rail mounting



Technical characteristics p. 71

Measure the electricity consumed by a single-phase or three-phase circuit downstream of the electricity distribution metering. Display electricity consumption in kWh, as well as other values such as current, active energy, reactive energy and power (depending on the catalogue number). Conform to standards IEC 62053-21/23, IEC 62052-11 and IEC 61010-1. MID compliance ensures accuracy of the metering with a view to recharging for the electricity used.

Pack	Cat.Nos		Single-phase meters
1	Non-MID 0 046 70	MID compliant	Direct connection 32 A - 1 module Pulse output
1	0 046 81		36 A - 2 modules Pulse output
1	0 046 72	0 046 78	63 A - 2 modules Pulse output
1	0 046 77	0 046 79	63 A - 2 modules RS 485 output
Three-phase meters			
1	Non-MID 0 046 73	MID compliant	Direct connection 63 A - 4 modules Pulse output
1	0 046 80	0 046 83	63 A - 4 modules RS 485 output
Connection with CT			
1	0 046 74	0 046 85	5 A - 4 modules pulse output
1	0 046 84	0 046 86	5 A - 4 modules RS 485 and pulse output
Pulse concentrator			
1	0 046 87		For collecting and transmitting measurements taken by 7 universal pulse electricity meters. Also collects data from other meters (gas meters, water meters, etc.) RS485 output 4 modules
Measurement concentrator			
1	4 120 00		Full or partial electricity metering for 5 uses: heating, cooling, domestic hot water, and power sockets + "other". 5 inputs for current transformers (up to 2 current transformers per input) 2 pulse inputs for water and gas metering LCD screen and 6-button keypad RJ45 IP output Power supply 110/230 VAC - 50/60 Hz 6 modules
Split core current transformer			
1	4 120 02		90 A max. for the measurement concentrator Cat.No 4 120 00. Accepts : 10 x 1.5 mm ² cables, or 7 x 2.5 mm ² cables, or 2 x 6 mm ² cables, or 1 x 10 or 16 mm ² cable

EMDX³ multi-function measuring units

┌ rail mounting



Technical characteristics p. 72

Conform to standards:
- IEC 61557-12
- IEC 62053-22 class 0.5 S
- IEC 62053-23 class 2

Pack	Cat.Nos	EMDX ³ modular
		For mounting on ┌ rail Width: 4 modules • LCD display • Measurement of currents, voltages, active, reactive and apparent power and internal temperature • Dual tariff metering: - Active energy consumed - Reactive energy consumed - Operating time - Power factor • THD voltages and currents up to order 51 • Programmable alarms on all functions • Outputs for controlling wiring devices, alarm feedback and pulse feedback
1	0 046 75	EMDX³ pulse unit Data transmission via pulses
1	0 046 76	EMDX³ RS 485 unit Data transmission via RS 485 communication interface and pulses

Add-on modules with integrated energy meter
p. 43



EMDX³ multi-function measuring units

for mounting on door or solid faceplate



0 146 68



0 146 69



0 146 73

Technical characteristics p. 72

Conform to standards:

- IEC 61557-12
- IEC 62053-22 class 0.5 S
- IEC 62053-23 class 2

Pack	Cat.Nos	EMDX ³ - Access	Pack	Cat.Nos	EMDX ³ - Premium (continued)
1	0 146 68	Multi-function measuring unit For mounting on door or solid faceplate Dimensions: 96 x 96 x 60 mm • LCD display • Measurement of currents, voltages, active, reactive and apparent power, internal temperature and power factor • Metering: - Active energy consumed or produced - Reactive energy consumed or produced - Operating time - Pulses • THD voltages and currents up to order 51 • Programmable alarms on all functions Can take 2 optional modules	1	0 146 73	Modules for EMDX³ - Premium multi-function measuring units RS 485 communication module MODBUS link
			1	0 146 74	Storage module Storage of active and reactive power over 62 days, the last 10 alarms and the average voltage and frequency values over 60 days max.
			1	0 146 75	Module with 2 inputs/2 outputs Up to 3 modules, i.e. 6 inputs/6 outputs, can be installed Outputs can be assigned to monitoring mode, remote control or timed remote control
			1	0 146 77	Temperature module Indication of the internal temperature and possibility of connecting 3 sensors for measuring the external temperature
1	0 146 71	Modules for EMDX³ - Access multi-function measuring unit RS485 communication module MODBUS link			Communication and supervision Web servers Enable remote viewing, via a web browser on PCs, smartphones, web viewers, tablet computers such as iPads, Archos, etc., of values collected on electricity meters and multi-function measuring units
1	0 146 72	1-output module Can be assigned to pulse feedback, alarm feedback or control of wiring devices	1	0 261 78	For 32 metering points (meters or multi-function measuring units)
			1	0 261 79	For an unlimited number of metering points (meters or multi-function measuring units)
					Legrand software dedicated to measurement For displaying the values collected from electricity meters or multi-function measuring units on a PC connected to the network
			1	0 261 88	For 32 metering points (supplied on CD)
			1	0 261 89	For an unlimited number of metering points (supplied on CD)
					Accessories IP converter For RS485/Ethernet conversion for connecting electricity meters and multi-function measuring units to an IP network Supply voltage: 90-260 V~ 50/60 Hz Dimension: 2 modules
1	0 146 69	EMDX³ - Premium Multi-function measuring units For mounting on door or solid faceplate Dimensions: 96 x 96 x 60 mm • LCD display • Measurement of currents, voltages, active, reactive and apparent power, internal temperature and power factor • Metering: - Active energy consumed or produced - Reactive energy consumed or produced - Operating time - Pulses • Individual harmonics up to order 63 • Programmable alarms on all functions Can take 4 optional modules			



EMDX³ electrical energy meters

└ rail mounting

Technical characteristics

Single-phase meters Cat.Nos 0 046 70/72/77/78/79/81

LCD display: 7 digits
 Resolution: 0.1 kWh
 Maximum indication: 99999.9 kWh
 Metrological LED: 1 Wh/pulse (Cat.No 0 046 70 : 0.5 Wh/pulse)
 Accuracy (EN 62053-21): class 1
 Reference voltage Un: 230 V-240 V
 Reference frequency: 50-60 Hz

Three-phase meters Cat.Nos 0 046 73/74/80/82/83/84/85/86

LCD display: 8 digits
 Resolution: 0.01 kWh⁽¹⁾
 Maximum indication: 99999.99 kWh⁽¹⁾
 Metrological LED: 0.1 Wh/pulse or 1 Wh/pulse
 Active energy accuracy (EN 62053-21): class 1
 Reactive energy accuracy (EN 62053-23): class 2
 Reference voltage Un:
 - Single-phase: 230-240 V
 - Three-phase: 230(400)-240(415) V
 Operating limit range (EN 62053-21, EN 62053-23):
 - Single-phase: 110 to 254 V
 - Three-phase: 110(190) to 254(440) V
 Pulse output: 1 pulse/10 Wh

Cat.Nos		0 046 70	0 046 81	0 046 72	0 046 77	0 046 78	0 046 79	0 046 73	0 046 80	0 046 82	0 046 83	0 046 74	0 046 84	0 046 85	0 046 86	
Number of modules		1	2	2	2	2	2	4	4	4	4	4	4	4	4	
Connection	Direct	•	•	•	•	•	•	•	•	•	•					
	Via a current transformer											•	•	•	•	
	Single-phase	•	•	•	•	•	•					•	•	•	•	
	Three-phase							•	•	•	•	•	•	•	•	
Max. current		32 A	36 A	63 A	63 A	63 A	63 A	63 A	63 A	63 A	63 A	5 A (CT)	5 A (CT)	5 A (CT)	5 A (CT)	
Metering and measurement	Total active energy	•	•	•	•	•	•	•	•	•	•	•	•	•	•	
	Total reactive energy							•	•	•	•	•	•	•	•	
	Partial active energy (reset)		•	•	•	•	•	•	•	•	•	•	•	•	•	
	Partial reactive energy (reset)							•	•	•	•	•	•	•	•	
	Active power			•	•	•	•	•	•	•	•	•	•	•	•	
	Reactive power							•	•	•	•	•	•	•	•	
	Apparent power							•	•	•	•	•	•	•	•	
	Current			•	•	•	•	•	•	•	•	•	•	•	•	
	Voltage			•	•	•	•	•	•	•	•	•	•	•	•	
	Frequency			•	•	•	•	•	•	•	•	•	•	•	•	
	Power factor			•	•	•	•	•	•	•	•	•	•	•	•	
	Time-of-use			•	•											
	Average active power							•	•	•	•	•	•	•	•	
	Max. average active power value							•	•	•	•	•	•	•	•	
Dual tariff								•								
Communication	Pulse output	•	•	•		•		•		•		•	•	•	•	
	RS 485 interface				•		•		•	•			•		•	
MID compliant						•	•			•			•		•	
Operating conditions	Reference temperature	23 °C ± 2 °C														
	Operating temperature	-20 to +55 °C	-10 to +45 °C					-5 to +55 °C								
	Storage temperature	-40 to +70 °C	-25 to +70 °C					-25 to +70 °C								
	Consumption		≤ 8 VA					≤ 4 VA per phase				≤ 1 VA per phase				
	Heat dissipation		≤ 6.5 W					≤ 6 W				≤ 4 W				

Interfacing with IP communication network

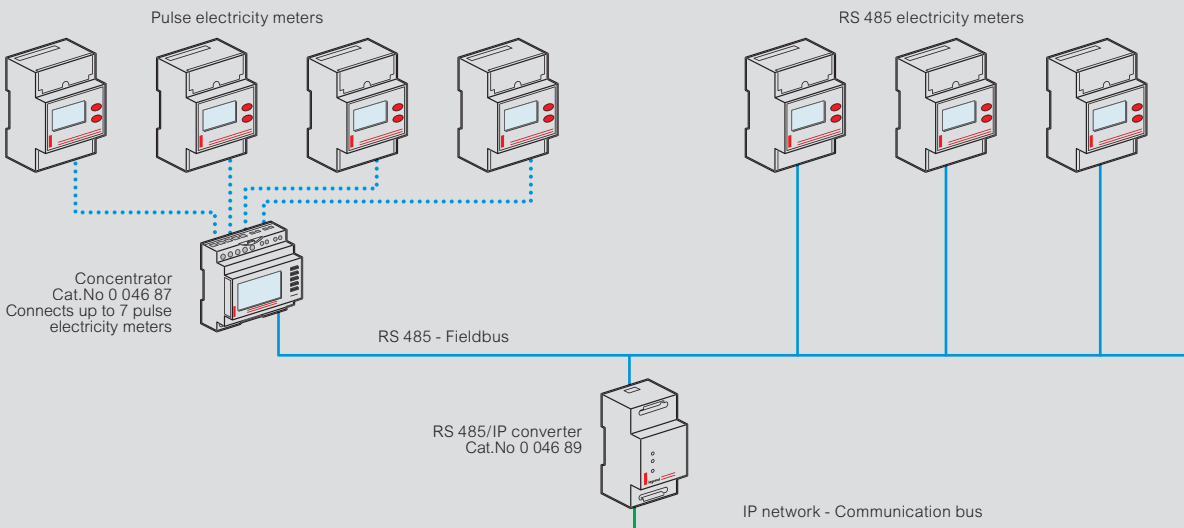

1: For direct connection meters
 If connected via transformers, the resolution and maximum indication depend on the transformation ratios of these transformers

EMDX³ multi-function measuring units

Technical characteristics

Cat.Nos		0 046 75/76	0 146 68	0 146 69	
Connection	Current measurement terminals	4 mm ²	6 mm ²	6 mm ²	
	Other terminals	2.5 mm ²	2.5 mm ²	2.5 mm ²	
Protection index	Front cover	IP 51	IP 52	IP 52	
	Casing	IP 20	IP 30	IP 30	
Weight		205/215 g	400 g	400 g	
Display		Backlit LCD	Backlit LCD	Backlit LCD	
Measurements		3P+N, 3P, 2P, 1P+N	3P+N, 3P, 2P, 1P+N	3P+N, 3P, 2P, 1P+N	
Voltage measurement	Direct	Phase/phase	50 to 520 V~	50 to 500 V~	18 to 700 V~
		Phase/neutral	28 to 300 V~	28 to 289 V~	11 to 404 V~
	From a PT	Primary	-	-	≤ 500 kV
		Secondary	-	-	60, 100, 110, 115, 120, 173, 190 V~
	Permanent overload between phases		760 V~	800 V~	760 V~
	Update period		1 s	1 s	1 s
Current measurement	From a CT	Primary	5 to 9999 A	≤ 9999 A	≤ 9995 A
		Secondary	5 A	5 A	1 or 5 A
	Minimum measurement		5 mA	5 mA	10 mA
	Input consumption		< 0.6 VA	< 0.6 VA	< 0.3 VA
	Display		0 to 9999 A	1 to 11 kA	0 to 11 kA
	Permanent overload		6 A	6 A	10 A
	Intermittent overload		60 A/1 s - 120 A/0.5 s	10 In/1 s	10 In/1 s
	Update period		1 s	1 s	1 s
	Max. CT x PT ratio		-	-	10000000
	Power measurement	Total	0 to 9999 kW/kvar/kVA	0 to 11 MW/Mvar/MVA	0 to 8000 MW/Mvar/MVA
Update period			1 s	1 s	
Frequency measurement	Measurement range	45.0 to 65.0 Hz	45.0 to 65.0 Hz	45.0 to 65.0 Hz	
	Update period		1 s	1 s	
Auxiliary power supply	50/60 Hz	200 to 277 V~ ±15%	110 to 400 V~ ±10%	110 to 400 V~ ±10%	
	DC	-	120 to 350 V= ±20%	120 to 350 V= ±20%	
	Consumption	< 5 VA	< 10 VA	< 10 VA	
Operating temperature		-10 °C to +55 °C	-10 °C to +55 °C	-10 °C to +55 °C	
Storage temperature		-20 °C to +70 °C	-20 °C to +85 °C	-20 °C to +85 °C	

Flush-mounting dimensions Cat.Nos 0 146 68/69

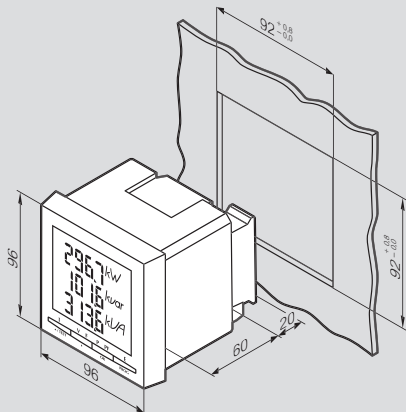

Fixing on door Cat.Nos 0 146 68/69

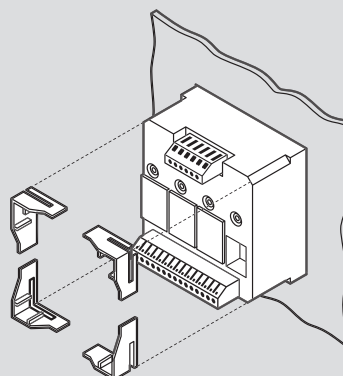

Fitting modules Cat.Nos 0 146 68/69

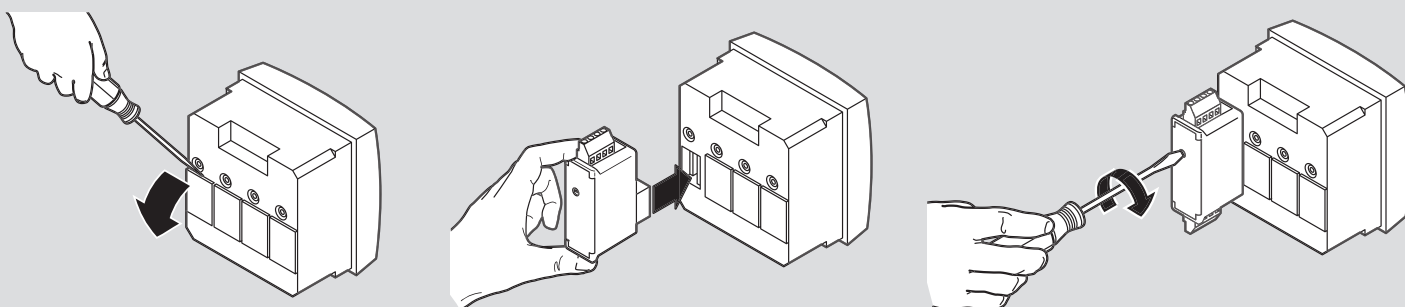

Connection solutions

Unbalanced three-phase network (3 or 4-wire)

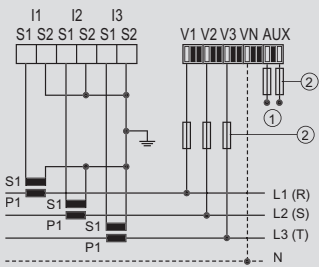

(3-wire)

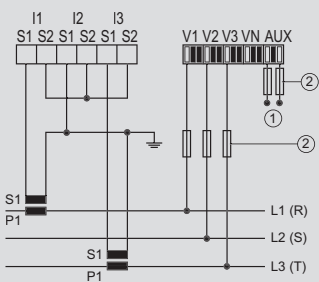

Balanced three-phase network (3 or 4-wire)

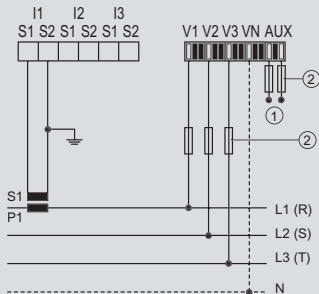

Single-phase network (2-wire)

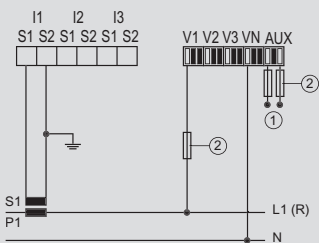

Two-phase network (2-wire)

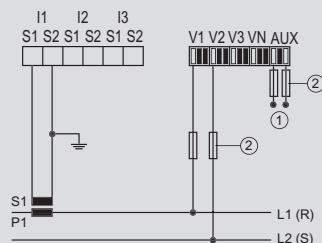

- ① Auxiliary power supply: 110 ... 400 VAC/120 ... 350 VDC
 ② Fuse: 0.5 A gG/BS 88 2A gG/0.5 A class CC

Wiring example of communication network

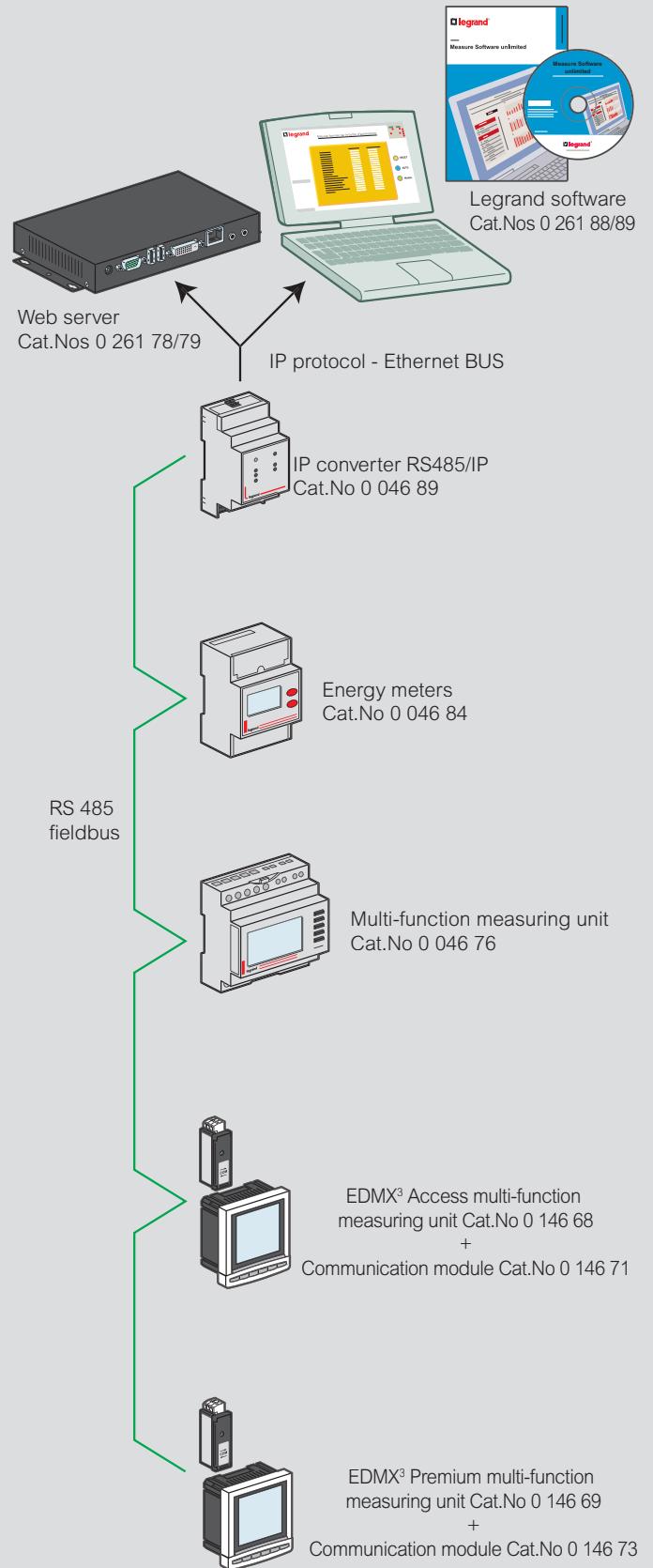



4 121 42

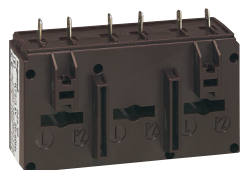

4 121 58



4 121 62

Technical characteristics [see e-catalogue](#)

Pack	Cat.Nos	Single-phase solid core current transformers	
		Used with ammeters, electricity meters or multi-function measuring units Current at the secondary: 5 A Can be fixed on plate, EN 60715 rail Cat.No 4 121 01/02/03/04/05/06/07, or bars Secondary connected by terminals or lugs Precision class: 0.5 % (1 % for Cat.No 4 121 01/02)	
		For 16 x 12.5 mm bar or Ø21 mm cable	
		Transformation ratio	Output (VA)
1	4 121 01	50/5	1.25
1	4 121 02	75/5	1.5
1	4 121 03	100/5	2
1	4 121 04	125/5	2.5
1	4 121 05	160/5	3
1	4 121 06	200/5	4
1	4 121 07	250/5	5
		For 32.5 x 10.5 and 25.5 x 15.5 mm bars or Ø27 mm cable	
1	4 121 12	400/5	10
1	4 121 14	600/5	12
		For 40.5 x 12.5 and 32.5 x 15.5 mm bars or Ø26 mm cable	
1	4 121 16	250/5	3
1	4 121 17	400/5	6
1	4 121 19	700/5	8
		For 40.5 x 10.5, 32.5 x 20.5 and 25.5 x 25.5 mm bars or Ø32 mm cable	
1	4 121 23	250/5	3
1	4 121 24	300/5	5
1	4 121 25	400/5	8
1	4 121 26	600/5	12
		For 50.5 x 12.5 and 40.5 x 20.5 mm bars or Ø40 mm cable	
1	4 121 31	700/5	8
1	4 121 32	800/5	8
1	4 121 33	1000/5	10
		For 65 x 32 mm bar	
1	4 121 36	600/5	8
1	4 121 38	800/5	12
1	4 121 39	1000/5	15
		For 84 x 34 mm bar	
1	4 121 42	1250/5	12
		For 127 x 38 mm bar	
1	4 121 46	1600/5	10
1	4 121 47	2000/5	15
1	4 121 49	3200/5	25
		For 127 x 54 mm bar	
1	4 121 50	1600/5	20
1	4 121 51	2000/5	25
1	4 121 52	2500/5	30
1	4 121 53	3200/5	30
1	4 121 54	4000/5	30

Pack	Cat.Nos	Three-phase solid core current transformers	
		Used with ammeters, electricity meters or multi-function measuring units Current at the secondary: 5 A For fixing directly on bars Secondary connected by terminals or lugs Precision class: 1 %	
		For three 20.5 x 5.5 mm bars	
1	4 121 57	Transformation ratio 250/5	Output (VA) 3
1	4 121 58	For three 30.5 x 5.5 mm bars 400/5 4	
		Single-phase split-core current transformers	
		Used with ammeters, electricity meters or multi-function measuring units Current at the secondary: 5 A For fixing directly on bars Secondary connected by terminals or lugs Precision class: 0.5 %	
		For 50 x 80 mm bar	
		Transformation ratio	Output (VA)
1	4 121 62	400/5	1.5
1	4 121 63	800/5	3
		For 80 x 120 mm bar	
1	4 121 64	1000/5	5
1	4 121 65	1500/5	8
		For 80 x 160 mm bar	
1	4 121 66	2000/5	15
1	4 121 67	2500/5	15
1	4 121 68	3000/5	20
1	4 121 69	4000/5	20
		Viking 3 disconnector block for measurement - 1 connection	
		With its accessories, allows intervention (measurement, maintenance, etc) on a current, voltage and power measuring circuit by keeping the current transformer secondary circuit closed	
		Colour	Nominal cross section (mm ²)
			Capacity
			Rigid wire (mm ²)
			Flexible wire (mm ²)
			Pitch (mm ²)
25	0 371 92	Grey	4 0.25 to 4 0.25 to 4 8

Current transformers (CT)

technical characteristics

■ Dimensions

Single-phase solid core current transformers

Cat.No 4 121 01/02/03/04/05/06/07

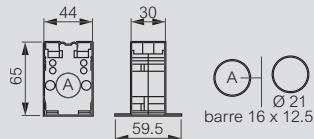

Cat.No 4 121 12/14

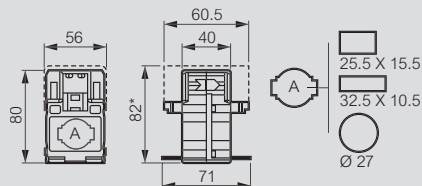

Cat.No 4 121 16/17/19

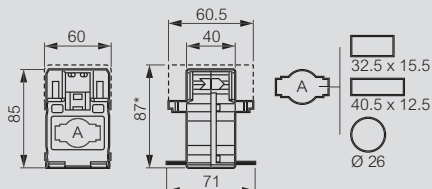

Cat.No 4 121 23/24/25/26

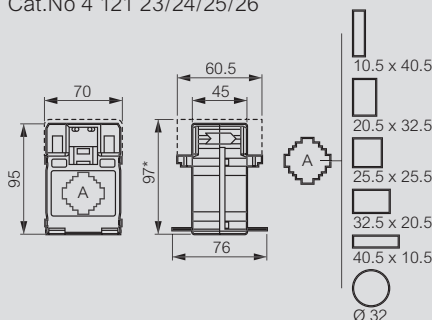

Cat.No 4 121 31/32/33

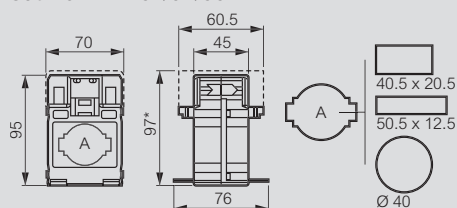

Cat.No 4 121 36/38/39/42/46/47/49/50/51/52/53/54

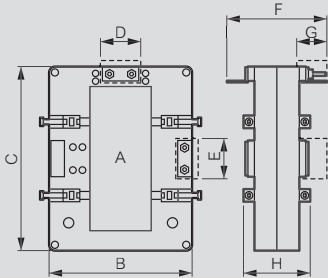

Cat.No	A	B	C	D	E	F	G	H
4 121 36/38/39	32 x 65	90	94	33.5	33.5	90	25	40
4 121 42	34 x 84	96	116	33.5	33.5	87	25	40
4 121 46/47/49	38 x 127	99	160	33.5	33.5	87	25	58
4 121 50/51/52/53/54	54 x 127	125	160	33.5	33.5	87	25	40

Single-phase split core current transformers

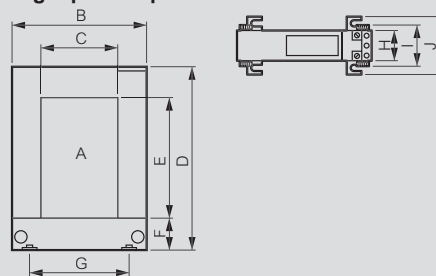

Cat.No	A	B	C	D	E	F	G	H	I	J
4 121 62/63	50 x 80	114	50	145	80	33	78	32	46	69
4 121 64/65	80 x 120	144	80	185	121	32	108	32	46	69
4 121 66/67/68/69	80 x 160	184	80	245	160	38	120	32	46	69

Three-phase solid core current transformers

Cat.No 4 121 57 for three 20.5 x 5.5 mm bars

Cat.No 4 121 58 for three 30.5 x 5.5 mm bars

For fixing directly on bars

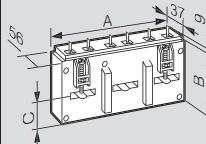

Cat.No	A	B	C
4 121 57	107	58.5	25
4 121 58	135	66.5	30

■ Maximum cable length between current transformers (CT) and meters

Size (A)	Cat.No	Max. output		Maximum cable length between current transformers & meters (m)		
		Class 0.5 (VA)	Class 1 (VA)	Cable 1.5mm ²	Cable 2.5mm ²	Cable 6mm ²
50	4 121 01		1.25	1.1	1.8	4.4
75	4 121 02		1.5	1.5	2.4	5.9
100	4 121 03	2		2.2	3.7	8.9
125	4 121 04	2.5		2.9	4.9	11.8
160	4 121 05	3		3.7	6.1	14.8
200	4 121 06	4		5.1	8.5	20.7
250	4 121 07	5		6.6	11.0	26.6
400	4 121 12	10		13.9	23.2	56.2
600	4 121 14	12		16.8	28.1	68.1
250	4 121 16	3		3.7	6.1	14.8
400	4 121 17	6		8.0	13.4	32.6
700	4 121 19	8		11.0	18.3	44.4
250	4 121 23	3		3.7	6.1	14.8
300	4 121 24	5		6.6	11.0	26.6
400	4 121 25	8		11.0	18.3	44.4
600	4 121 26	12		16.8	28.1	68.1
700	4 121 31	8		11.0	18.3	44.4
800	4 121 32	8		11.0	18.3	44.4
1000	4 121 33	10		13.9	23.2	56.2
600	4 121 36	8		11.0	18.3	44.4
800	4 121 38	12		16.8	28.1	68.1
1000	4 121 39	15		21.2	35.4	85.8
1250	4 121 42	12		16.8	28.1	68.1
1600	4 121 46	10		13.9	23.2	56.2
2000	4 121 47	15		21.2	35.4	85.8
3200	4 121 49	25		35.8	59.8	145.0
1600	4 121 50	20		28.5	47.6	115.4
2000	4 121 51	25		35.8	59.8	145.0
2500	4 121 52	30		43.1	72.0	174.6
3200	4 121 53	30		43.1	72.0	174.6
4000	4 121 54	30		43.1	72.0	174.6
3 X 250	4 121 57		3	3.7	6.1	14.8
3 X 400	4 121 58		4	5.1	8.5	20.7
400	4 121 62	1.5		1.5	2.4	5.9
800	4 121 63	3		3.7	6.1	14.8
1000	4 121 64	5		6.6	11.0	26.6
1500	4 121 65	8		11.0	18.3	44.4
2000	4 121 66	15		21.2	35.4	85.8
2500	4 121 67	15		21.2	35.4	85.8
3000	4 121 68	20		28.5	47.6	115.4
4000	4 121 69	20		28.5	47.6	115.4

Cat.Nos	Page N°	Pack	Cat.Nos	Page N°	Pack	Cat.Nos	Page N°	Pack	Cat.Nos	Page N°	Pack	Cat.Nos	Page N°	Pack	Cat.Nos	Page N°	Pack
0 026 00			0 046 84	69	1	0 491 56	62	1	4 063 20	44	1	4 074 26	34	1	4 075 60	34	1
			85	-	1	83	63	1	4 064 00			27	-	1	61	-	1
0 026 71	64	1	86	-	1	26	62	1				28	-	1	62	-	1
0 036 00			87	-	1	0 802 00			4 064 00	28	10	29	-	1	63	-	1
			89	70	1	0 802 99	67	10	01	-	10	30	-	10	64	-	1
0 036 58	64	1	0 047 00			4 062 00			03	-	10	31	-	1	65	-	1
60	-	1	0 047 04	63	10	4 062 50	44	1	04	-	10	32	-	10	66	-	1
71	-	1	40	66	1	52	-	1	06	-	10	33	-	1	67	-	1
80	-	1	41	-	1	56	-	1	11	-	10	34	-	1	4 076 00		
0 037 00			42	66	1	58	-	1	12	-	10	35	-	1	4 076 17	34	1
			43	-	1	59	-	1	23	-	10	36	-	1	18	-	1
0 037 05	60	1	44	-	1	60	-	1	31	-	10	37	-	1	19	-	1
0 041 00			45	-	1	62	-	1	32	-	10	38	-	1	20	-	1
			70	60	1	64	-	1	34	-	10	67	-	1	21	-	1
0 041 01	67	10	82	-	1	66	-	1	36	-	10	68	-	1	22	-	1
07	-	10	91	68	1	76	-	1	38	-	10	69	-	1	23	-	1
13	-	10	92	-	1	80	-	1	39	-	10	70	-	1	24	-	1
0 042 00			93	-	1	82	-	1	40	-	5	71	-	1	25	-	1
			0 146 00			85	-	1	41	-	5	72	-	1	26	-	1
0 042 10	68	1	0 146 68	70	1	86	-	1	49	-	5	73	-	1	27	-	1
80	67	10	69	-	1	87	-	1	50	-	5	74	-	1	28	-	1
85	-	10	71	-	1	88	-	1	57	-	5	75	-	10	29	-	1
91	-	5	72	-	1	89	-	1	59	-	5	76	-	1	30	-	1
92	-	5	73	-	1	90	-	1	60	-	1	77	-	1	62	-	1
0 044 00			74	-	1	91	-	1	61	-	1	78	-	1	63	-	1
			75	-	1	92	-	1	69	-	1	79	-	1	64	-	1
0 044 05	67	10	77	-	1	93	-	1	70	-	1	4 075 00			65	-	1
06	-	10	0 227 00			95	-	1	77	-	5	4 075 02	34	1	66	-	1
09	62	1	0 227 97	44	1	4 063 00			79	-	5	03	-	1	68	-	10
0 046 00			0 261 00			4 063 03	44	2	80	-	1	04	-	1	69	-	1
			0 261 78	70	1	04	-	2	81	-	1	05	-	1	70	-	10
0 046 70	69	1	79	-	1	06	-	1	89	-	1	06	-	1	71	-	1
72	-	1	88	-	1	07	-	10	90	-	1	07	-	1	72	-	1
73	-	1	89	-	1	07	67	10	92	-	1	08	-	1	73	-	1
74	-	1	0 371 00			10	44	1	93	-	1	09	-	1	74	-	1
75	-	1				11	-	1	95	-	1	10	-	1	75	-	1
76	-	1	0 371 92	74	25	12	-	1	4 065 00			11	-	1	76	-	1
77	-	1	0 491 00			13	-	3	4 065 27	28	1	12	-	1	4 077 00		
78	-	1				14	-	1	28	-	1	13	-	1	4 077 33	34	1
79	-	1	0 491 20	53	10	15	-	1	35	-	1	14	-	1	34	-	1
80	-	1	21	-	10	16	-	1	36	-	1	15	-	1	35	-	1
81	-	1	4 074 00			17	-	1	38	-	1	54	-	1	36	-	1
82	-	1				18	-	1	39	-	1	55	-	1	37	-	1
83	-	1	4 074 25	34	1	19	-	1	43	-	1	56	-	1	38	-	1
						4 076 00			44	-	1	57	-	1	40	-	1
									46	-	1	58	-	1	41	-	1
									47	-	1	59	-	1			

Cat.Nos	Page N°	Pack	Cat.Nos	Page N°	Pack	Cat.Nos	Page N°	Pack	Cat.Nos	Page N°	Pack	Cat.Nos	Page N°	Pack	Cat.Nos	Page N°	Pack
4 077 42	34	10	4 079 32	34	1	4 080 95	35	1	4 089 66	36	1	4 091 14	36	10	4 092 81	36	1
43	-	1	33	-	1				67	-	1	15	-	1	82	-	1
44	-	1	34	-	1	4 081 00			83	-	1	16	-	1	4 093 00		
45	-	1	62	35	1	4 081 43	35	1	84	-	1	17	-	1	4 093 28		
46	-	1	63	-	1	45	-	1	85	-	1	18	-	1	29	-	1
92	-	1	64	-	1	46	-	1	86	-	1	19	-	1	30	-	1
93	-	1	65	-	1	47	-	1	87	-	1	20	-	1	31	-	1
94	-	1	66	-	1	48	-	1	88	-	1	40	-	1	32	-	1
95	-	1	67	-	1	49	-	1	89	-	1	41	-	1	33	-	1
96	34	1	69	-	1	50	-	1	90	-	1	42	-	1	34	-	1
98	-	5	70	-	1	51	-	1	91	-	1	94	-	1	35	-	1
99	-	1	71	-	1	52	-	1	92	-	1	95	-	1	36	-	1
4 078 00			72	-	1	53	-	1	93	-	1	96	-	1	37	-	1
4 078 00	34	5	73	-	1	4 088 00			94	-	1	97	-	1	38	-	1
01	-	1	74	-	1	4 088 64	36	1	95	-	1	4 092 00			39	-	1
02	-	1	75	-	1	65	-	1	4 090 00			4 092 00	36	1	40	-	1
03	-	1	76	-	1	66	-	1	4 090 15	36	1	01	-	1	41	-	1
04	-	1	77	-	1	67	-	1	16	-	1	02	-	1	42	-	1
05	-	1	4 080 00			68	-	1	57	-	1	03	-	1	62	-	1
06	-	1	4 080 22	35	1	69	-	1	58	-	1	04	-	1	63	-	1
51	-	1	23	-	1	70	-	1	59	-	1	05	-	1	64	-	1
52	-	1	24	-	1	71	-	1	60	-	1	06	-	1	4 094 00		
53	-	1	25	-	1	72	-	1	61	-	1	07	-	1	4 094 25	37	1
54	-	1	26	-	1	73	-	1	62	-	1	08	-	1	28	-	1
55	-	1	27	-	1	74	-	1	63	-	1	28	-	1	30	-	1
57	-	1	29	-	1	75	-	1	64	-	1	29	-	1	32	-	1
58	-	1	30	-	1	76	-	1	65	-	1	30	-	1	33	-	1
59	-	1	31	-	1	77	-	1	66	-	1	46	-	1	34	-	1
60	-	1	32	-	1	78	-	1	67	-	1	47	-	1	35	-	1
61	-	1	33	-	1	4 089 00			68	-	1	48	-	1	36	-	1
62	-	1	34	-	1	4 089 34	36	1	69	-	1	49	-	1	37	-	1
63	-	1	35	-	1	35	-	1	70	-	1	50	-	1	38	-	1
64	-	1	36	-	1	36	-	1	71	-	1	51	-	1	44	-	1
65	-	1	37	-	1	37	-	1	89	-	1	52	-	1	47	-	1
4 079 00			80	-	1	38	-	1	90	-	1	53	-	1	49	-	1
4 079 20	34	1	82	-	1	39	-	1	4 091 00			54	-	1	51	-	1
21	-	1	83	-	1	40	-	1	4 091 06	36	1	55	-	1	52	-	1
22	-	1	84	-	1	41	-	1	07	-	1	56	-	1	53	-	1
23	-	1	85	-	1	42	-	1	08	-	1	57	-	1	54	-	1
24	-	1	87	-	1	43	-	1	09	-	1	58	-	1	55	-	1
26	-	1	88	-	1	44	-	1	10	-	1	59	-	1	56	-	1
27	-	1	89	-	1	45	-	1	11	-	1	60	-	1	57	-	1
28	-	1	90	-	1	46	-	1	12	-	10	80	-	1	58	-	1
29	-	1	91	-	1	47	-	1	13	-	1				59	-	1
30	-	1	92	-	1	48	-	1									
31	-	1	93	-	1												
			94	-	1												

Catalogue number index

Cat.Nos	Page N°	Pack	Cat.Nos	Page N°	Pack	Cat.Nos	Page N°	Pack	Cat.Nos	Page N°	Pack	Cat.Nos	Page N°	Pack	Cat.Nos	Page N°	Pack
4 094 60	37	1	4 097 16	38	1	4 097 75	38	1	4 098 21	39	1	4 098 87	39	1	4 100 22	40	1
92	-	1	17	-	1	76	-	1	22	-	1	88	-	1	23	-	1
95	-	1	18	-	1	77	-	1	23	-	1	89	-	1	24	-	1
97	-	1	19	-	1	78	-	1	24	-	1	90	-	1	25	-	1
99	-	1	20	-	1	79	-	1	30	-	1	91	-	1	26	-	1
4 095 00			21	-	1	80	-	1	31	-	1	92	-	1	27	-	1
4 095 00	37	1	22	-	1	81	-	1	32	-	1	93	-	1	28	-	1
01	-	1	28	-	1	82	-	1	33	-	1	94	-	1	33	-	1
02	-	1	29	-	1	83	-	1	34	-	1	95	-	1	34	-	1
03	-	1	30	-	1	84	-	1	35	-	1	96	-	1	35	-	1
04	-	1	31	-	1	85	-	1	36	-	1	97	-	1	36	-	1
05	-	1	32	-	1	86	-	1	37	-	1	98	-	1	37	-	1
06	-	1	33	-	1	87	-	1	38	-	1	4 099 00			38	-	1
07	-	1	34	-	1	88	-	1	39	-	1	4 099 00	39	1	39	-	1
08	-	1	35	-	1	89	-	1	40	-	1	01	-	1	40	-	1
26	-	1	41	-	1	90	-	1	41	-	1	02	-	1	41	-	1
29	-	1	42	-	1	91	-	1	42	-	1	03	-	1	97	-	1
31	-	1	43	-	1	92	-	1	43	-	1	04	-	1	98	-	1
33	-	1	44	-	1	93	-	1	44	-	1	08	-	1	99	-	1
34	-	1	45	-	1	94	-	1	45	-	1	09	-	1	4 101 00		
35	-	1	46	-	1	95	-	1	46	-	1	11	-	1	4 101 00	40	1
36	-	1	47	-	1	96	-	1	47	-	1	12	-	1	01	-	1
37	-	1	48	-	1	97	-	1	48	-	1	13	-	1	02	-	1
38	-	1	49	-	1	98	-	1	49	-	1	14	-	1	21	-	1
39	-	1	50	-	1	99	-	1	50	-	1	20	-	1	22	-	1
40	-	1	51	-	1	4 098 00			51	-	1	22	-	1	23	-	1
41	-	1	52	-	1	4 098 00	38	1	52	-	1	23	-	1	24	-	1
42	-	1	53	-	1	01	-	1	53	-	1	24	-	1	25	-	1
59	38	1	54	-	1	02	-	1	54	-	1	25	-	1	26	-	1
60	-	1	55	-	1	03	-	1	55	-	1	26	-	1	27	-	1
61	-	1	56	-	1	04	39	1	66	-	1	34	-	1	28	-	1
62	-	1	57	-	1	05	-	1	67	-	1	35	-	1	34	-	1
63	-	1	58	-	1	06	-	1	68	-	1	36	-	1	35	-	1
64	-	1	59	-	1	07	-	1	69	-	1	37	-	1	36	-	1
65	-	1	60	-	1	08	-	1	70	-	1	4 100 00			37	-	1
66	-	1	61	-	1	09	-	1	71	-	1	4 100 07	40	1	38	-	1
67	-	1	62	-	1	10	-	1	72	-	1	08	-	1	39	-	1
68	-	1	63	-	1	11	-	1	73	-	1	09	-	1	40	-	1
69	-	1	64	-	1	12	-	1	76	-	1	10	-	1	41	-	1
70	-	1	65	-	1	13	-	1	77	-	1	11	-	1	47	-	1
71	-	1	66	-	1	14	-	1	78	-	1	12	-	1	48	-	1
72	-	1	67	-	1	15	-	1	79	-	1	13	-	1	49	-	1
73	-	1	68	-	1	16	-	1	80	-	1	14	-	1	50	-	1
74	-	1	69	-	1	17	-	1	81	-	1	15	-	1	51	-	1
4 097 00			70	-	1	18	-	1	82	-	1	20	-	1	52	-	1
4 097 15	38	1	71	-	1	19	-	1	83	-	1	21	-	1	53	-	1
			72	-	1	20	-	1	84	-	1				54	-	1
			73	-	1				85	-	1						
			74	-	1				86	-	1						



FOLLOW US
ALSO ON

@ www.legrand.com

 www.youtube.com/legrand

 twitter.com/@legrand



World Headquarters
and International Department
87045 Limoges Cedex - France
Tel.: + 33 (0) 5 55 06 87 87
Fax: + 33 (0) 5 55 06 74 55